

Bolero Turbo (XL)

OPERATING MANUAL



700.470.015 B (Digital manual - English)

Firmware: V1.0.0
HMI: V1.0.0

- Model-no:**
- BRLXLF-007
 - BRLXLF-009
 - BRLXLF-024
 - BRLXLF-025
 - BRLXLF-027
 - BRLXLF-030
 - BRLXLF-031
 - BRLXLF-033

All rights reserved.

No part of this document may be copied and/or published by means of printing, photocopying, microfilming or by any other means whatsoever without the prior written consent of the manufacturer. This also applies to the included drawings and/or diagrams.

The information in this document is based on data that was available at the time the design, the material characteristics and the operating methods were published, meaning that this document is subject to change.

The original instructions for this manual have been written in English. Other language versions of this manual are a translation of the original instructions.

For this reason, the instructions are merely a guideline for the installation, maintenance and repair of the machine shown on the front cover.

This document applies to the standard version of this machine.

The manufacturer therefore declines all liability for any damage arising from specifications that deviate from the standard version of the machine delivered to you.

This document has been compiled with the utmost care. However, the manufacturer cannot be held liable for any errors it contains or the consequences thereof.

Table of contents

1. General	1
2. Parts and functions.	1
2.1 Parts	1
2.2 Optional water filter	2
2.3 Optional raiser set.	2
2.4 Controls.	2
3. Start up	3
4. Your beverage	7
4.1 Personalise your beverage.	7
4.2 Select your beverage.	8
4.2.1 Cup tray folds up or down.	8
4.2.2 Simultaneous dispense	9
4.3 Cancelling instant related beverages	10
4.4 Screensaver	11
4.5 Energy-saving mode (ECO).	11
5. Cleaning.	12
5.1 Weekly cleaning	12
5.2 Monthly cleaning	14
6. Programming menu	17
6.1 Maintenance menu	18
6.1.1 Rinse the mixing system	19
6.1.2 Descale.	21
6.1.3 Water filter management	28
6.1.4 Hot-key rinsing function	31
6.1.5 Cleaning management.	32
6.1.6 Descale management	34
6.1.7 Canister calibration	37
6.1.8 Pump calibration	41
6.1.9 Input test	43
6.1.10 Output test	46
6.1.11 Cleaning instructions	50
6.1.12 Counters	53
6.1.13 Maintenance history	58
6.2 Beverage menu	60
6.2.1 Add beverage to screen.	61
6.2.2 Change beverage name.	63
6.2.3 Change beverage icon	65
6.2.4 Change beverage price	67
6.2.5 Recipes.	69
6.2.6 Select ingredients canisters	83
6.2.7 Change ingredient name.	86
6.2.8 Customize beverage strength.	88
6.2.9 Set default volume	90
6.2.10 Simultaneously dispensable beverages	91

6.3	Machine menu	92
6.3.1	Date	93
6.3.2	Time	94
6.3.3	Language	95
6.3.4	Screensaver management	96
6.3.5	Background	98
6.3.6	Display brightness	99
6.3.7	Sound level feedback	100
6.3.8	Boiler temperature	102
6.3.9	Energy-saving mode (ECO)	103
6.3.10	Security settings	105
6.3.11	Connected devices	110
6.3.12	Reset to factory settings	112
6.3.13	Set blocking times	114
6.3.14	Set automatic ON/OFF times	116
6.4	Software menu	118
6.4.1	Machine and software information	119
6.4.2	Error log	120
6.4.3	Warning log	121
6.4.4	Import machine settings	122
6.4.5	Export machine settings	124
6.4.6	Update software	126
6.4.7	Export machine log	128
6.4.8	Software update history	130
6.5	Online info	131
7.	Warnings and errors	132
7.1	Warnings	132
7.2	Error messages	134
7.3	Other problems	136
8.	Appendix	138
8.1	Filter information and water hardness	138
8.2	Door switch functionality	138
8.3	Basic machine configurations	139
8.3.3	Bolero Turbo (standard)	139
8.3.1	Bolero Turbo (specials)	139
8.3.2	Bolero Turbo XL (standard)	139
8.3.4	Pre-selected ingredients and beverages	140
8.4	PIN code security settings	146
8.5	Special functions	148
8.5.1	Cancel beverage on/off	148
8.5.2	Quick rinse	148

1. General

- ▶ Always read the safety instructions (700.403.347).
To avoid possible damage, these safety instructions must be read, understood and followed.
- ▶ Manuals are subject to change, scan the QR code to retrieve current information.
- ▶ All pictures are of the Bolero Turbo.
However, they also apply to the Bolero Turbo XL.



2. Parts and functions

2.1 Parts

1. descaling cap
2. canisters
3. canister outlet
4. ventilation duct
5. mixing system
6. beverage outlet
7. hot water outlet
8. safety key
9. USB connection
10. programming button
11. door-key
12. cup tray
13. drip tray plate
14. drip tray with float
15. ventilation system
16. water inlet
17. electrical connection
18. on/off switch

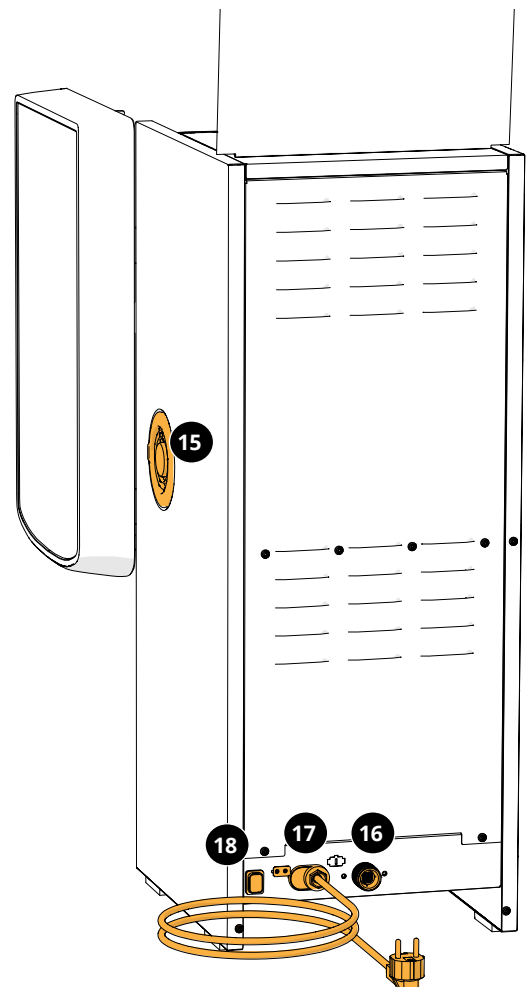
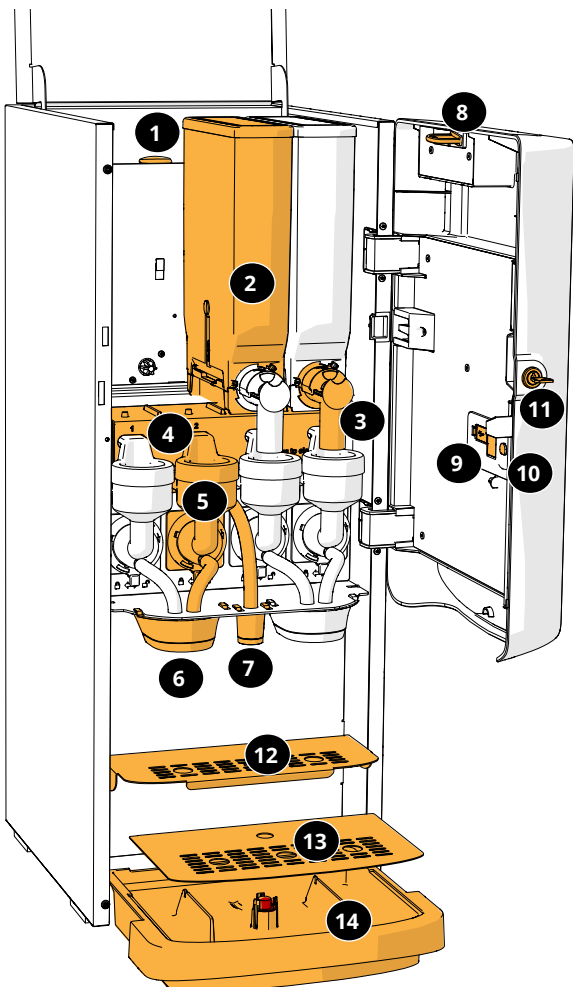

2.2 Optional water filter

To enjoy your beverages even more and improve the performance of your Bolero, we recommend installing a water softener filter. You can request one from Bravilor Bonamat BV.

- ▶ *When you install a water softener filter you must notify the Bolero of its presence as described in [§6.1.3 on p.28](#).*

2.3 Optional raiser set

The pedestal raises the standard Bolero Turbo (XL) by approx. 90 mm and the maximum tap height to 396 mm.







- Raiser set Bolero Turbo: 7.270.512.101
- Raiser set Bolero Turbo XL: 7.270.513.101

2.4 Controls

The basic buttons are described underneath.

Overall the Bolero reacts after the release when a button is pressed.

- ▶ *If no button is pressed within 5 minutes, the Bolero returns to the beverage selection screen.*

controls	function
	navigate between screens
	start an action
	confirm (<i>not saved yet</i>)
	save adjustments
	cancel
	browse the available options on a screen
	increase and decrease

▶ *All screen shots in this manual are in English.*

▶ *The beverages, recipes and settings used are only examples.*

3. Start up

- ▶ *The Bolero can display different screens, depending on the model of the Bolero.*

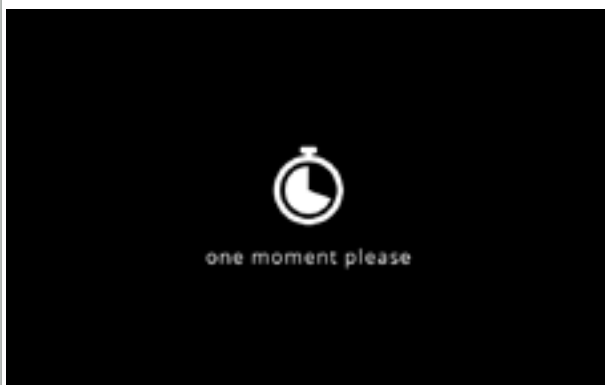

3a

Initialisation.

- wait for the next screen

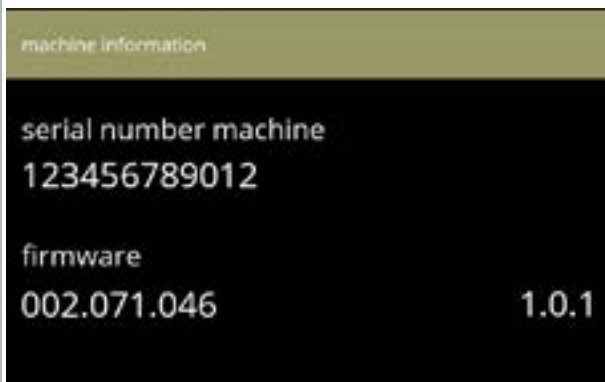

3b

Machine information.

- after a few seconds the next screen will appear depending the status of the machine:

- ▶ *First install already completed, the next screen is [3j](#).*

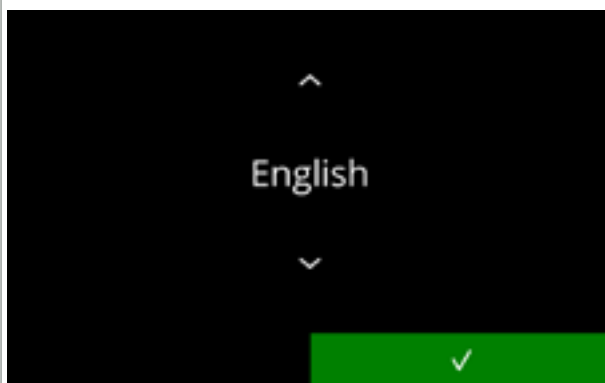

3c

Installation, select your language:

- press or to scroll through the available languages
- press to confirm
- ▶ *The installation menu is only shown when the machine is switched on for the first time or is switched on after the factory settings have been reset, see [§6.3.12 on p.112](#).*

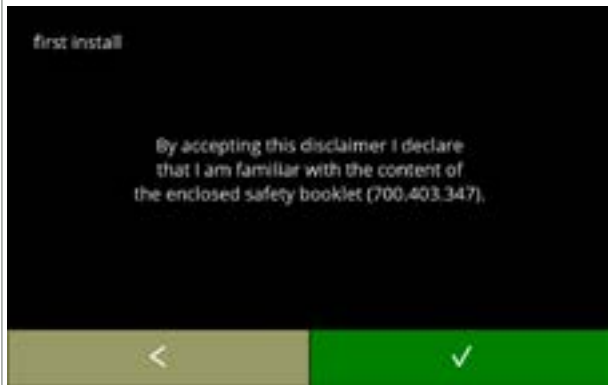

3d

Read the safety book!

- press to go the previous screen
- press to confirm

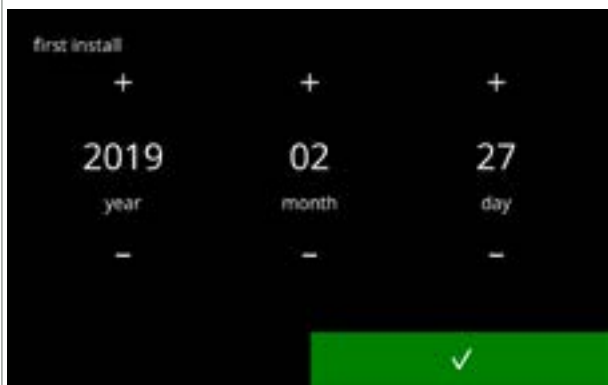

3e

Set the current date:

- press or to set the current year, month and day
- press to confirm

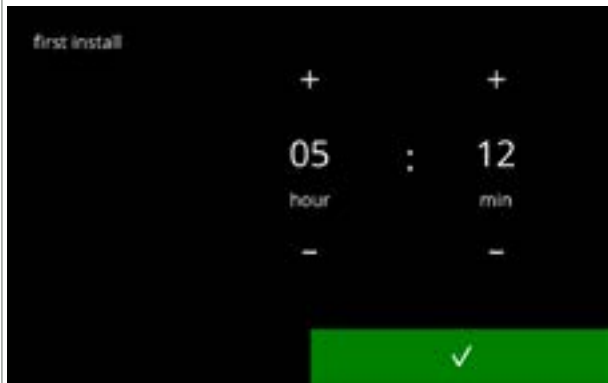

3f

Set the current time:

- press or to set the current the hour and minutes
- press to confirm



3g

Information screen:

- fill the canisters with ingredients according to the instructions on the screen
 - ▶ *Only use ingredients that are suitable for vending machines.*
- press to confirm
 - ▶ *The screen depends on the configuration of the machine, see [§8.3 on p.139](#).*
 - ▶ *The values can be changed in the beverage menu, see [§6.2.6 on p.83](#).*

3h

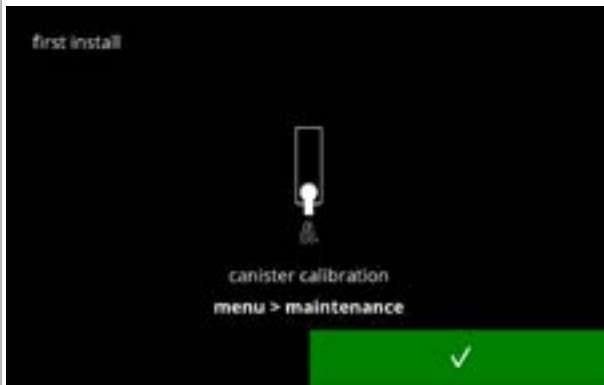

Information screen
• press to confirm

- ▶ *Calibration is essential for a correct dosage of the ingredients and can be done in the maintenance menu, see [§6.1.7 on p.37](#).*

3i

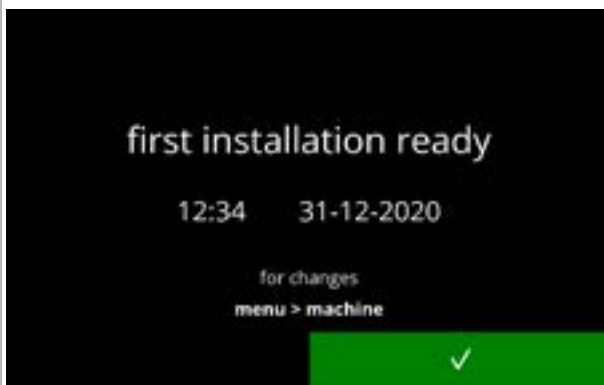

Information screen:
• press to confirm

- ▶ *The date, time and language can be changed in [§6.3 on p.92](#).*

3j



Filling information.
• wait for the next screen

3k



Information screen - heating up:
• wait for the next screen

- ▶ *The progress circle shows a percentage of the temperature compared to the set temperature.*

- The machine is ready for use.



31

4. Your beverage

If you press the image of a beverage, it will be prepared immediately in the single outlet version. In all other versions, you must press the image and then start..

If you want to personalise the drink, select one of the icons in fig. 4.1a, then press the drink of your choice.

4.1 Personalise your beverage

► *These settings are used in preparing a personal beverage and are not saved.*

Options

Strength:



- press the beans to select the beverage strength (to adjust see [§6.2.8 on p.88](#))

Beverage size:



The letters (S=small / M=medium / L=large) represents the three steps in volume

- press the "letters" to select the beverage cup size

Decanter/cup mode:



- flip up/down the cup tray to switch between decanter/cup beverages
- or press the "image with arrow" and follow the on screen instructions

4.1a

Selecting a beverage:

- touch the beverage of your choice
- *When the ◀ ▶ buttons are visible, it means that more than one beverage screen is available.*
- *A double outlet Bolero Turbo (XL), which can dispense drinks simultaneously, has different screens (see [§4.2.2 Simultaneous dispense on p.9](#)).*



4.1b

Preparing a beverage:

- please wait



4.1c

4.2 Select your beverage

4.2.1 Cup tray folds up or down

The Bolero Turbo has a cup tray that folds up and down. This cup tray is up to place a decanter and down to hold a cup. A sensor will monitor the position of the cup tray.

When the cup tray is up, the machine is in the 'decanter mode' and the beverage selection screen shows all the available decanter beverages (screen [4.2.1b](#)). When the cup tray is down, the beverage selection screen shows all available cup beverages (screen [4.2.1a](#)).

You can also press the cup or decanter icon (see fig. [4.1a](#)). When the cup tray is up, a cup icon is displayed; when it is down, a decanter icon is displayed. If the user presses this icon, a pop-up will appear with instructions on how to tilt the plate up (screen [4.2.1d](#)) or down (screen [4.2.1c](#)).

If the user follows these instructions, the beverage selection screen will change from cups to decanters or vice versa. The pop-up is visible for 3 seconds and disappears more quickly if the plate sensor detects a change within those 3 seconds.

When switching from decanters to cups or vice versa, the volume selector is set to the default volume. The strength selector also shows the default strength (if available).

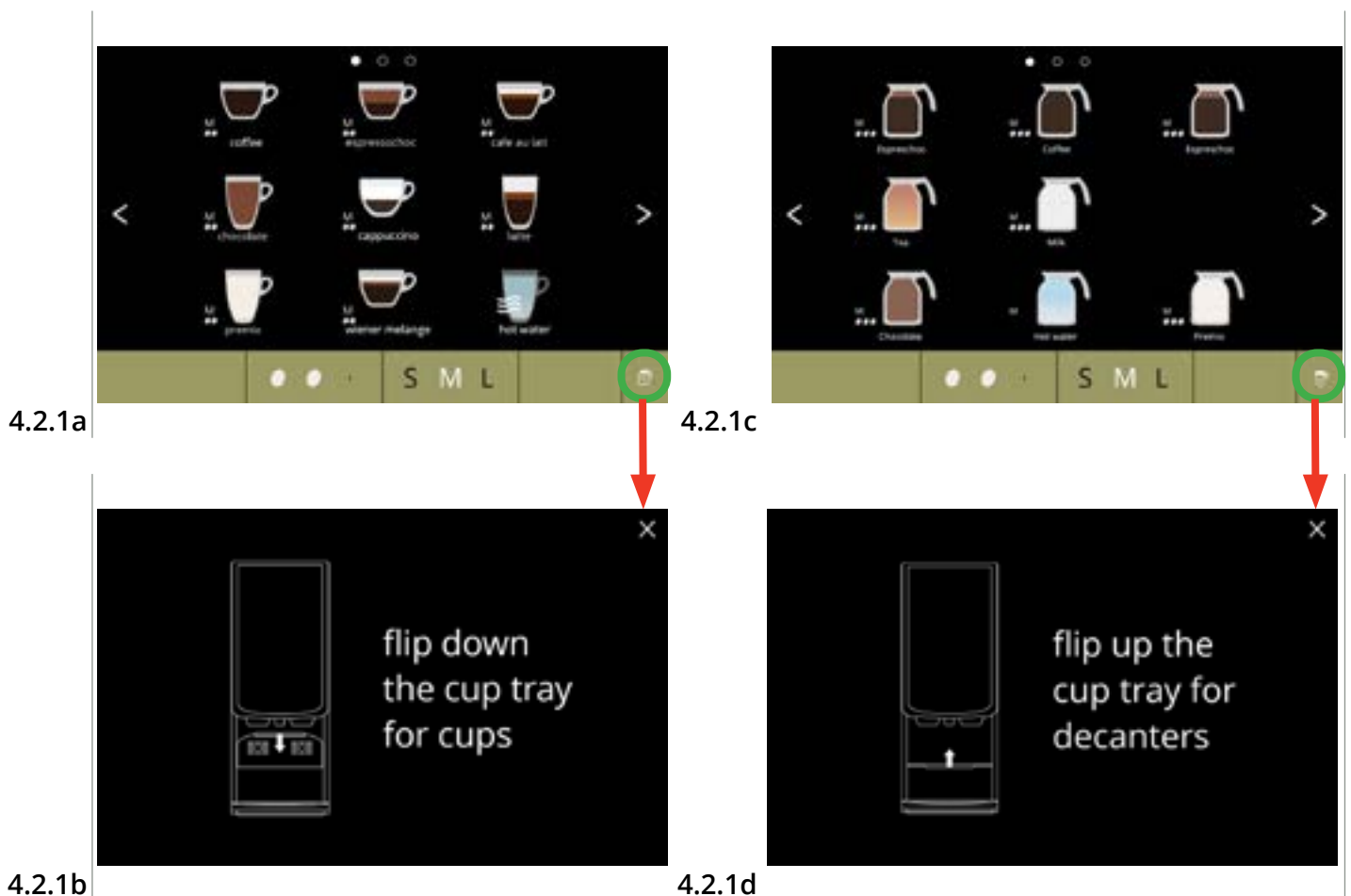

4.2.2 Simultaneous dispense

Bolero Turbo's with **multiple** outlets (see [§8.3 Basic machine configurations on p.139](#)) can dispense (certain) beverages simultaneously.

Hot water cannot be dispensed at the same time as another beverage.

The selected beverage is shown on the side of the display above the outlet from which it will be dispensed. The rest of the display shows only the beverages that can be dispensed at the same time through the other outlet.

When the first drink is selected and another can be dispensed at the same time, the display will look like screen [4.2.2a](#), shown here for a dispense from the right outlet only.

The volume and strength now only apply to the beverage not yet selected. This part of the screen is the same as the standard beverage selection screen (with no beverages selected).

Right outlet is ready for dispensing (cups)



4.2.2a

Both outlets are ready for simultaneous dispensing (cups).

► *This screen always has a black background, even if a custom background has been set for the beverage selection screen.*



4.2.2b

Dispensing hot water.

► *This screen always has a black background, even if a custom background has been set for the beverage selection screen.*



4.2.2c

4.3 Cancelling instant related beverages

When a beverage is selected, immediately a cancel button appears.

The cancel button  may have a limited dimension but the dosing action can always be stopped wherever the screen is touched.

The cancel function is enabled by default and can only be turned off in [§6.3.11 on p.110](#)

When a beverage is cancelled, the mixer continues to run for a few seconds to clean the mixing system.

Hot water is stopped immediately.



4.3a

Cancel a beverage:

- touch anywhere on the screen to cancel the beverage



4.3b

Information screen:

- this screen is displayed to indicate the beverage has been cancelled.

4.4 Screensaver

If the screen has not been touched for a certain time, the screensaver starts.
The screensaver timer can be set (time) and disabled in [§6.3.4 on p.96](#).



4.4a

Screensaver:

- touch anywhere on the screen to return to the beverage selection screen

4.5 Energy-saving mode (ECO)

The device is equipped with an energy-saving mode (ECO) this is used to save energy consumption when the machine is not used (e.g. overnight or during a weekend).

When energy-saving mode becomes active, the following actions are performed:

- water level control disabled
- boiler heating disabled
- backlight display set to low percentage
- fan disabled

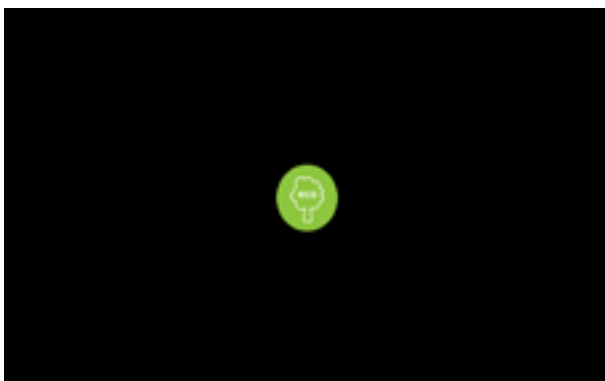

4.5a

The energy control consist out of a (customised) screensaver with a symbol as semi transparent overlay.
The energy-saving mode has priority over the screensaver.

- touch anywhere on the screen to return to the beverage selection screen
- ▶ *Depending on the switch-off time, it can take a few minutes before the machine is ready for use again.*

5. Cleaning

It is important that the Bolero is kept clean, what can be cleaned (*period depending on pollution*):

Daily	Weekly	Monthly
start rinsing program for the mixing system, §6.1.1 on p.19	drip tray	ventilation system
	mixing system	canister(s)
	the outside	

- ▶ Never clean parts of the Bolero in the dishwasher, only if this is explicitly stated.
- ▶ Do not use any aggressive cleaning agents.

5.1 Weekly cleaning

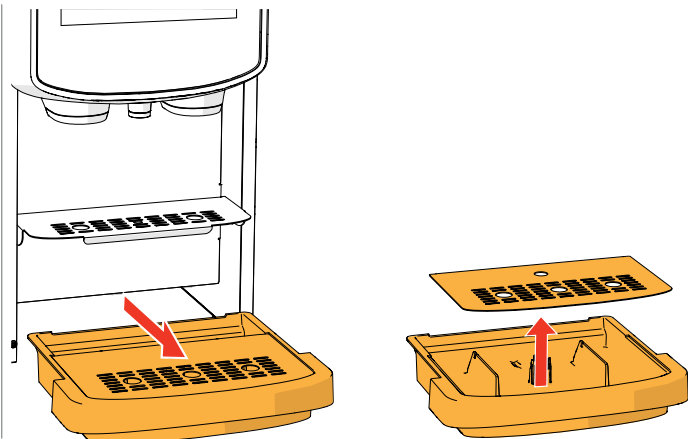

Drip-tray:

1. pull the complete drip tray forward
 2. empty the drip tray
 3. clean the drip tray (including grid), using *hot soapy water*
 4. dry everything and place them back in place
- ▶ Check whether the "red float" is still in place.



Mixing system:

1. open the door and lid
2. close the "yellow" slider of the canister outlets
3. turn the outlets counter-clockwise

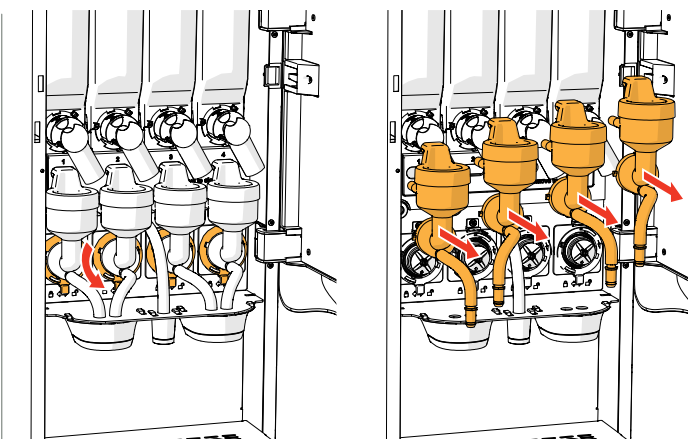

4. turn the fixation ring counter-clockwise
5. remove the hoses from the metal plate
6. remove the complete mixing system

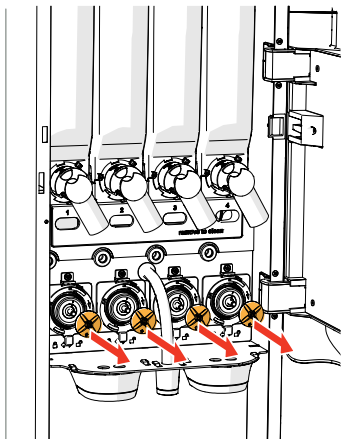

7. remove the mixer
8. remove both beverage outlets

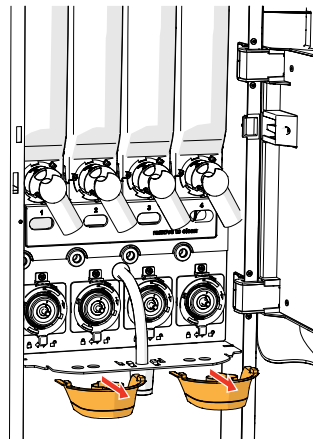

9. clean the indicated parts, using a *damp* cloth

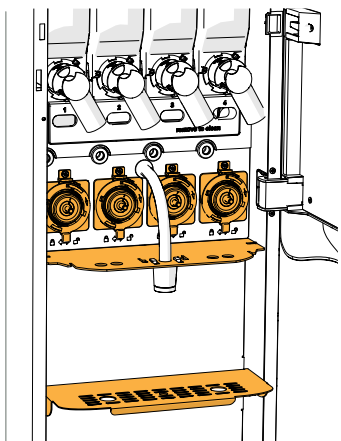

10. clean the removed parts (*dishwasher proof* (<math><65^{\circ}\text{C}</math>))
11. remount the mixing system in reverse order
 - *Pay attention to the flat sides of the shaft and the mixer.*
12. reconnect the hose to the mixing system and the outlet
13. replace the ingredient canister(s) in the correct position
14. open the "yellow" slider of the canister(s)
15. close the lid and door

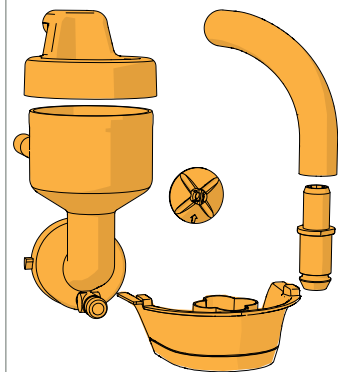

► *To prevent clogging of ingredient that has fallen into the mixing cup, it is recommended to rinse the machine after the daily cleaning procedure, see [§6.1.1 on p.19](#).*

The outside:

1. switch off the machine (due to the touchscreen)
2. clean the outside with a *damp* cloth
3. switch the machine back on

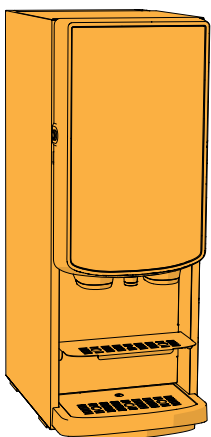

5.2 Monthly cleaning

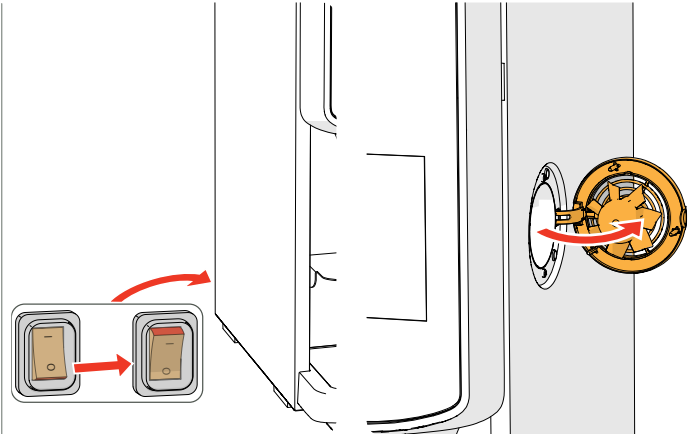

Ventilation system:

1. switch off the machine
2. open the fan to the back

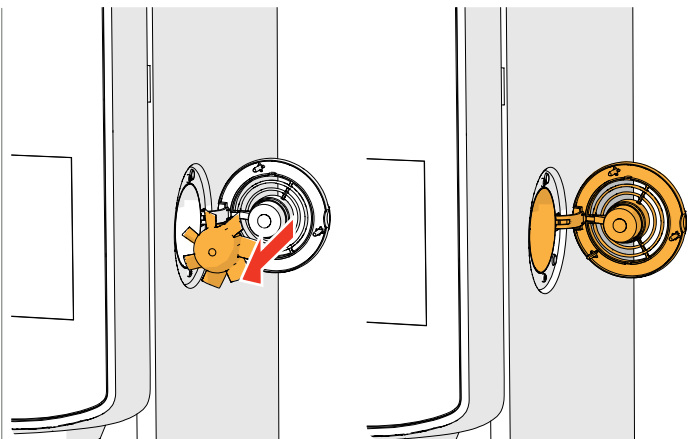

3. carefully pull the rotor of the motor
4. clean the fan housing and grid, using a *damp* cloth

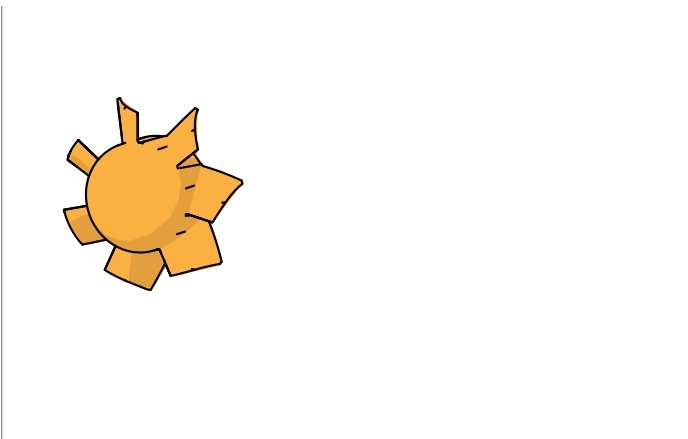

5. clean the fan rotor, using *hot soapy water*
6. dry everything and place the rotor back in place
7. switch the machine back on

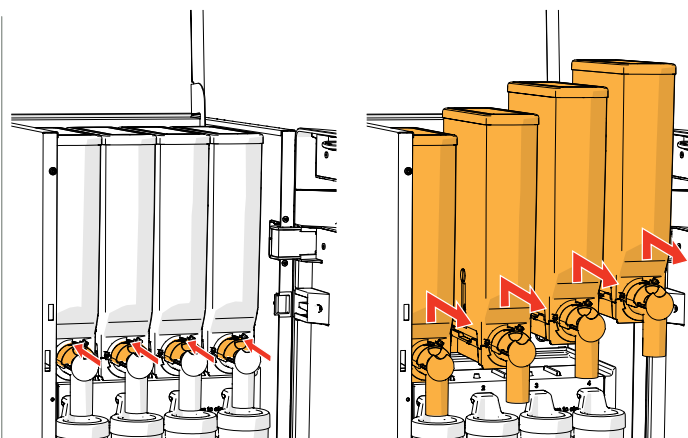

Fan duct:

1. open the door and lid
2. close the "yellow" slider of the canister outlet(s)
3. take the canister(s) out of the machine

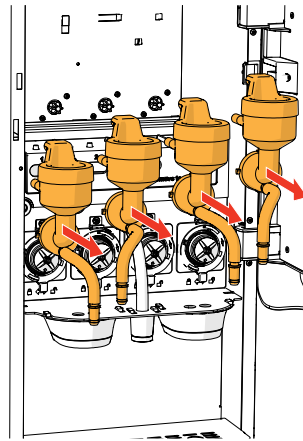
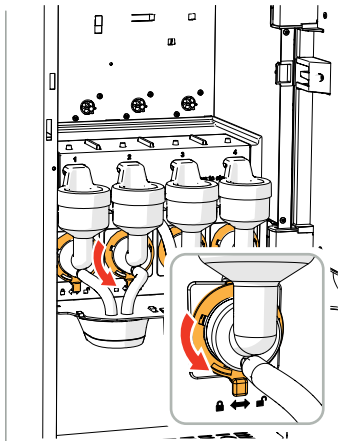

4. turn the fixation ring counter-clockwise
5. remove the complete mixing system

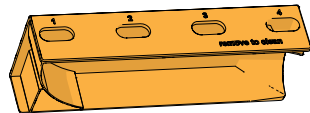
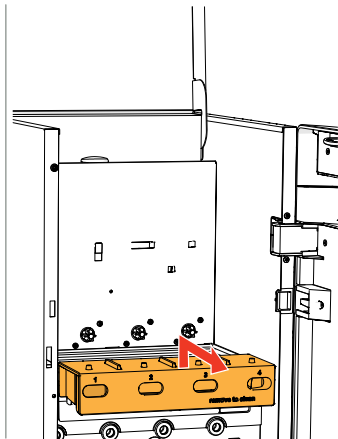

6. remove the fan duct
 7. clean the fan duct, using *hot soapy water*
- *Be aware that everything has been dried very well.*

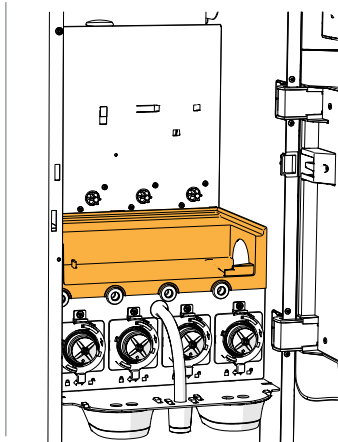

8. clean the inside of the machine with a *damp* cloth
9. replace the fan duct
10. replace the canister(s) in its/their correct position
11. open the "yellow" slider of the canister(s)
12. close the lid and door

Canister(s):

1. open the door and lid
2. close the "yellow" slider of the canister outlet(s)
3. take the canister(s) out of the machine

4. pour the ingredients in a dry bowl
5. unlink the outlet from the canister

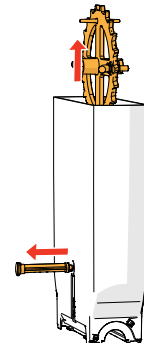
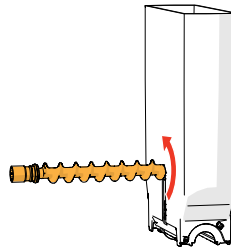
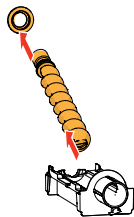
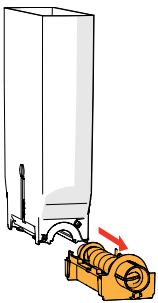
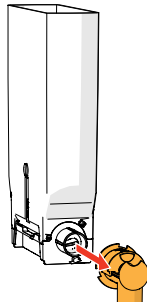
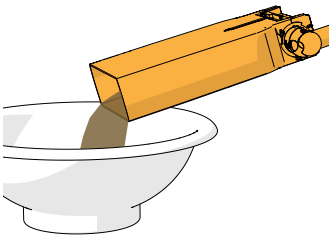
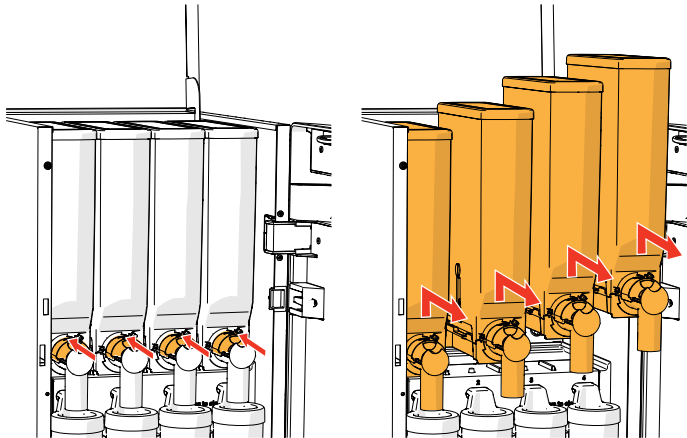

6. take apart the canister(s)
7. clean the canister and outlet with a brush

► *Do **not** use water to prevent the ingredients from clumping and clogging the canister.*

8. refill the canister(s)
9. replace the canister(s) in its/their correct position
10. open the "yellow" slider of the canister(s)
11. close the lid and door

► *To prevent clogging of ingredient that has fallen into the mixing cup, it is recommended to rinse the machine after the daily cleaning procedure, see [§6.1.1 on p.19](#).*

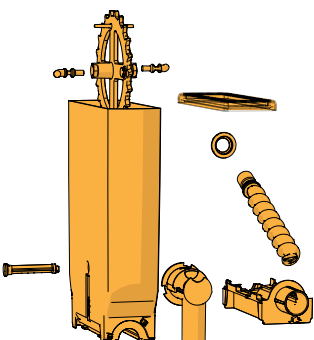

6. Programming menu

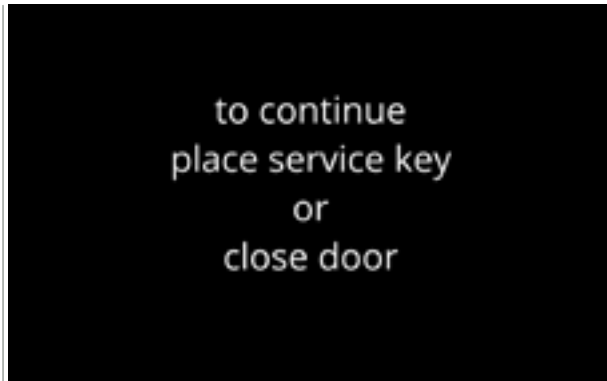

To access the programming menu:

- open the door of the Bolero this message appears on the screen
- insert the service key (no. [8 on p.1](#))
- press the programming button (no. [10 on p.1](#))

► *All screen shots in this manual are in English.*

In the programming menu select one of the available options:

- press **◀** or **▶** to select the next option of the “programming menu”
- press the “text area” to select the next level for that menu
- press **✕** to exit the programming menu and return to the beverage selection menu

► *If a PIN code is not set, all menu items are available.*

If a PIN code is set, the user can enter the menu with or without a PIN code.

The menu items secured by PIN codes will be greyed out, see [§8.4 on p.146](#).

► *If no button is pressed within 5 minutes, the Bolero returns to the beverage selection screen.*

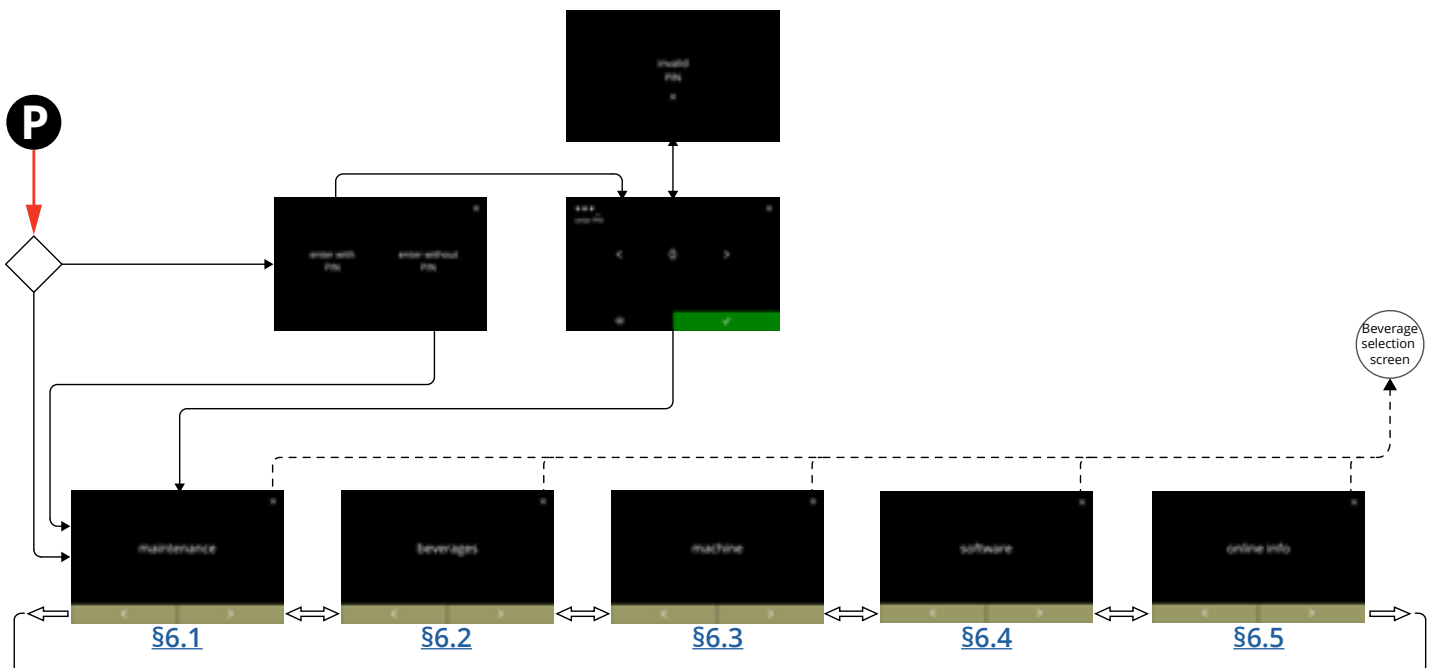

6.1 Maintenance menu

The maintenance menu contains all features that are available regarding the maintenance of the vending machine.

Select one of the available options:

- press **◀** or **▶** to select the next option of the maintenance menu
- press the "text area" to select the next level for that menu
- press **⌂** to go back to [chapter 6. Programming menu on p.17.](#)

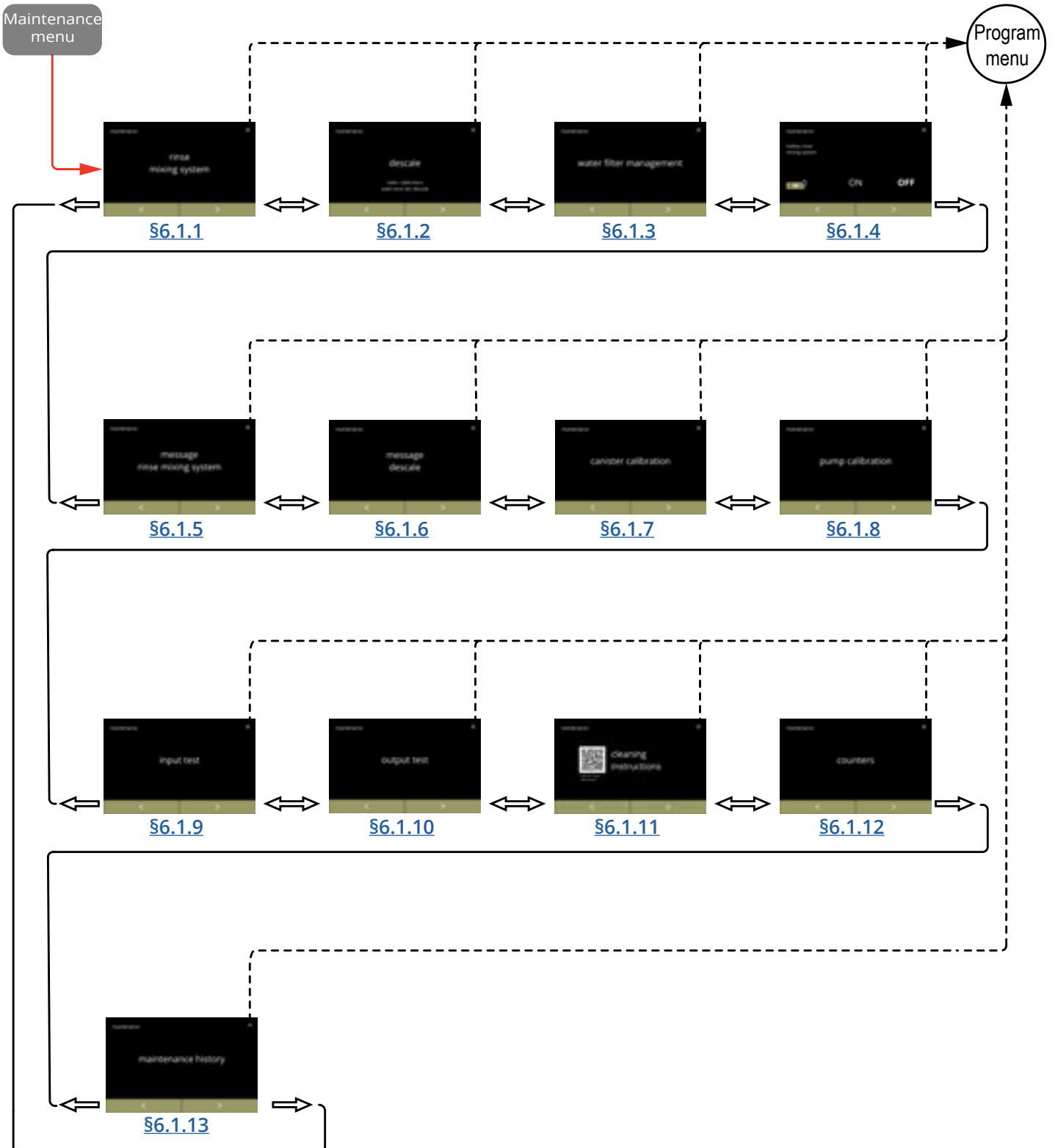

6.1.1 Rinse the mixing system

To maintain the correct functioning of the Bolero, the mixing system must be rinsed daily and cleaned weekly, see [§5.1 on p.12](#).

This procedure rinses the mixing systems and the outlet hoses.

- ▶ *The mixing system can also be rinsed without opening the door using a 'hotkey'.
To set this function, see [§6.1.4 on p.31](#)*

Necessities:

- container (0,5 litre)



6.1.1

The rinsing procedure:

- press "rinse mixing system" to select
- press or to scroll through the maintenance menu

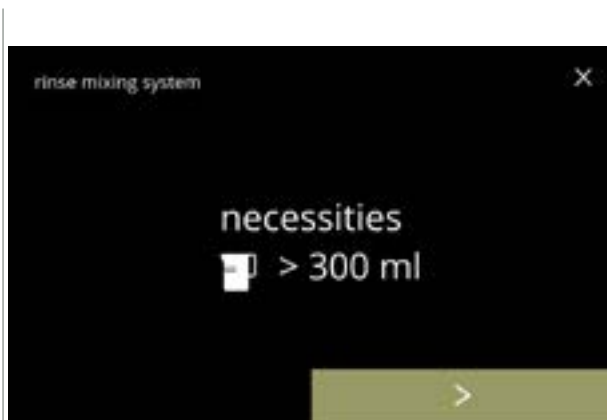

6.1.1a

Information screen:

- make sure all necessities are available
- press to go to the next screen
- ▶ *The quantity varies per machine*
 - » 2 mixing systems: 200 ml
 - » 3 mixing systems: 300 ml
 - » 4 mixing systems: 400 ml



6.1.1b

Information screen:

- place an empty container under the beverage outlet
- press to confirm
- press to go to the previous screen

Start rinsing:

- press **start** to begin the rinsing



6.1.1c

Rinsing:

- wait for the process to finish
 - ▶ *Hot water from the outlet*
- press **cancel** to abort



6.1.1d

Information screens:

- screen [6.1.1](#) is displayed after a few seconds



6.1.1e



6.1.2 Descale

If the water hardness is set correctly for the descaling signal (see [§6.1.6 on p.34](#)), descaling the Bolero will remove all limescale. This will extend the life-cycle of the Bolero.

Necessities:

- descale agent (recommended: "RENEGITE", our proven descaling agent)
- measuring jug
 - » 1 litre jug (Bolero turbo)
 - » 2 litre jug (Bolero turbo XL)
- funnel
- bucket (10 litre)
- average time: ± 40 minutes
- safety gloves and goggles

► *The descaling process cannot be interrupted after screen [6.1.2c!](#)*



6.1.2

The descaling procedure:

- press "descale" to select
- press or to scroll through the maintenance menu



6.1.2a

Preparation:

- make sure all necessities are available
- press to go to the next screen



6.1.2b

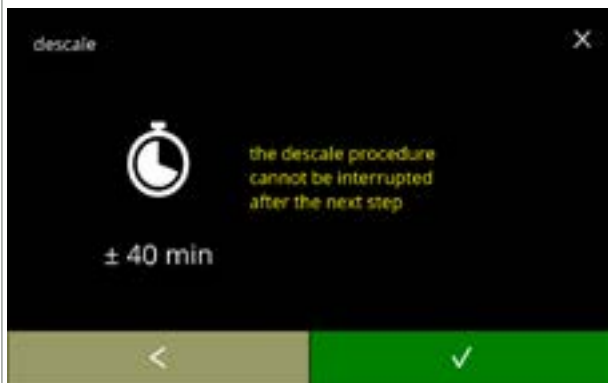

Preparation:

- follow the instructions on the screen
- press to go to the next screen
- press to go to the previous screen
- *The number / position of the canisters, mixer units and outlet(s) may vary per configuration, see [§8.3 on p.139](#).*



6.1.2c

Information screen:

- average length of time
- press  to confirm and continue the descaling procedure
- press  to go the previous screen

► *The descaling process cannot be interrupted after this screen!*

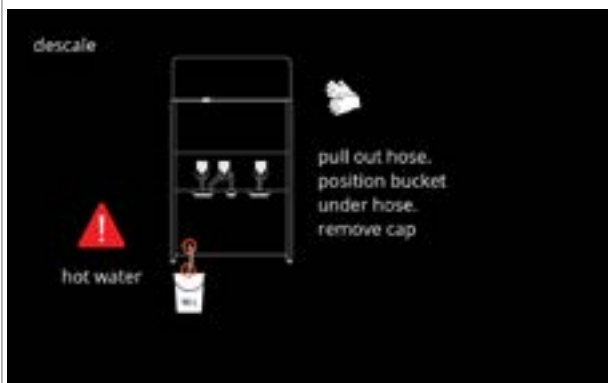

6.1.2d

Drain the machine:

- follow the instructions on the screen

► *Wear protecting gloves, hot water!*

- when the water flows out of the hose, the following screen is displayed



6.1.2e

Draining the machine:

- time indication needed for draining
- when the boiler is empty, the following screen is displayed



6.1.2f

Close the hose:

- follow the instructions on the screen
- press  to go to the next screen



6.1.2g

Prepare the descaling solution:

- follow the instructions on the screen
 - ▶ *Wear safety gloves and safety goggles.*
 - ▶ *The descaling agent must be dissolved completely.*
- press **>** to go to the next screen



6.1.2h

Preparation:

- follow the instructions on the screen
- press **>** to go to the next screen
 - ▶ *Place the bucket and measuring jug under **all** the outlets (including the hot water outlet).*
 - ▶ *The number / position of the outlet(s) may vary per configuration, see [§8.3 on p.139](#).*



6.1.2i

Preparation:

- follow the instructions on the screen
- press **>** to go to the next screen
 - ▶ *Wear safety gloves and safety goggles.*
 - ▶ *Do not leave the machine unattended while a descaling solution is in the machine.*



6.1.2j

Start descaling:

- follow the instructions on the screen
- press **start** to begin the descaling

Descaling:

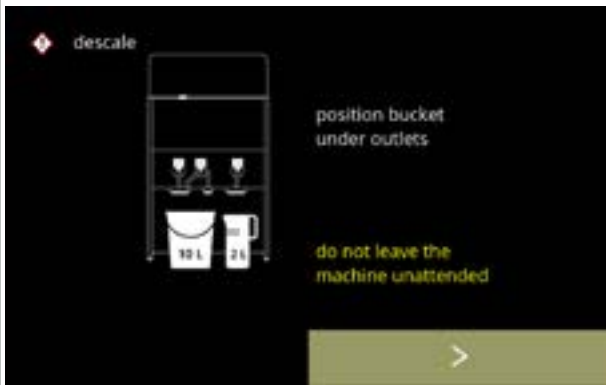

- ▶ *Make sure that the bucket and measuring jug are placed under the outlets, in the next step, water with descaling solution will come out of **all** the outlets (including the hot water outlet).*
- press **▶** to go to the next screen
- ▶ *The number / position of the outlet(s) may vary per configuration, see [§8.3 on p.139](#).*

6.1.2k

Descaling:



- the boiler is heating up, wait for the next screen

6.1.2l

Descaling:



- when the timer has expired the next screen appears and hot water with descaling solution comes out of the outlets

6.1.2m

Descaling - warning screen:

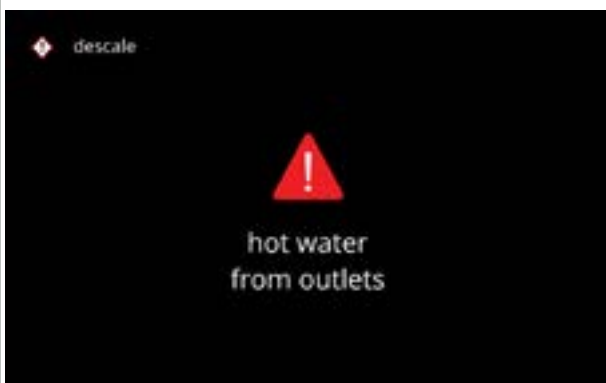

- wait for the next screen
- ▶ *Hot water with descaling solution will come out of the outlets.*

6.1.2n

Descaling:

- wait for the next screen

► *Hot water with descaling solution flows out **all** of the outlets.*



6.1.2o

Descaling - draining:

- follow the instructions on the screen

► *Wear safety gloves and safety goggles, the water is hot and contains descaling solution.*

- when the water flows out of the hose, the next screen is displayed

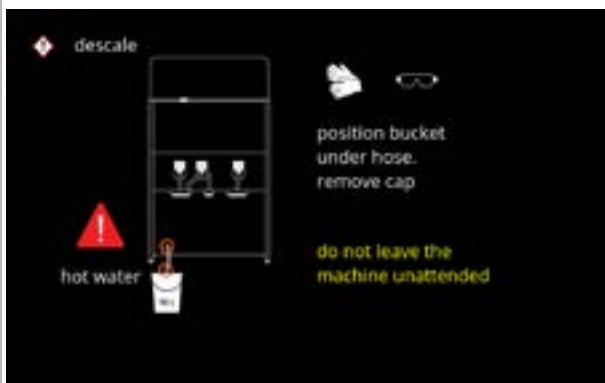

6.1.2p

Descaling - draining:

- time indication needed for draining

- when the boiler is empty, the next screen is displayed



6.1.2q

Descaling - draining:

- follow the instructions on the screen

- press  to go to the next screen

► *Remove and empty the bucket.*



6.1.2r



6.1.2s

Descaling - rinse:

- follow the instructions on the screen
 - ▶ Use an empty bucket.
 - ▶ Place the bucket also under **all** the outlets (including the hot water outlet).
- press  to go to the next screen
 - ▶ The number / position of the outlet(s) may vary per configuration, see [§8.3 on p.139](#).



6.1.2t

Descaling - rinse:

- the boiler is filling, wait for the next screen



6.1.2u

Descaling - rinse warning screen:

- wait for the next screen
 - ▶ Water will come out of **all** the outlets.



6.1.2v

Descaling - rinsing:

- wait for the next screen

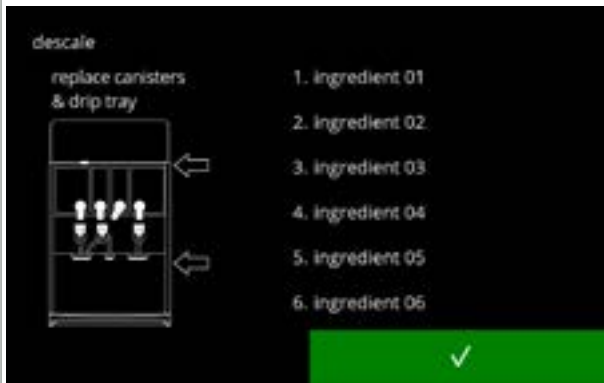

6.1.2w

Descaling - ending:

- follow the instructions on the screen
 - press  to confirm every things has been restored
- *The number / position of the canisters may vary per configuration, see [§8.3 on p.139](#).*

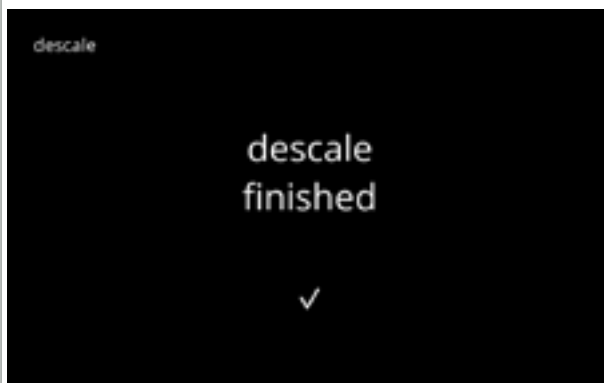

6.1.2x

Information screen:

- screen [6.1.2](#) is displayed after a few seconds



6.1.2y

Warning screen interrupted descaling process:

- press  to continue the procedure where it was interrupted and to finish the descaling process

6.1.3 Water filter management

If a water filter is installed, replaced or removed must be confirmed in the software so that the counter is updated. A water filter lessens lime-scale deposits and reduces impurities in the water. The Bolero also does not need to be descaled so often, see [§8.1 on p.138](#). Additionally, it ensures a consistent quality of the hot beverage in both taste and aroma.

water filter settings	default	minimum	maximum
capacity (litre)	<i>OFF</i>	100	10000
months shelf life		1	24

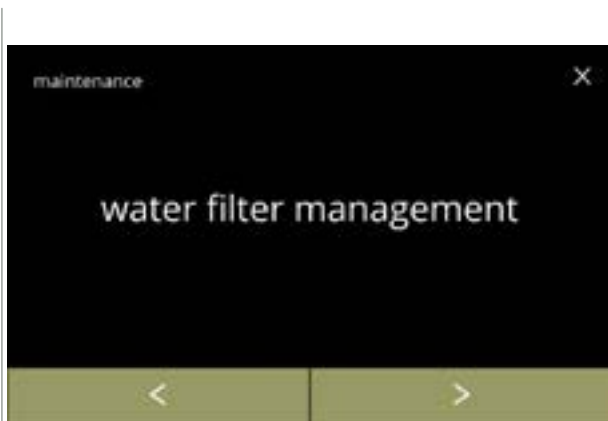

6.1.3

- Install, replace or remove the water filter:
- press "water filter management" to select
 - » water filter **already** installed go to screen [6.1.3c](#)
 - » water filter **not yet** installed, go to the next screen
 - press **◀** or **▶** to scroll through the maintenance menu

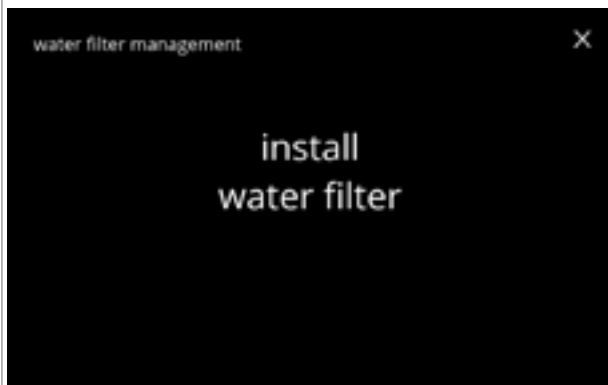

6.1.3a

- Installing:
- press "install water filter" to select
 - ▶ *Read the instructions that come with the filter.*

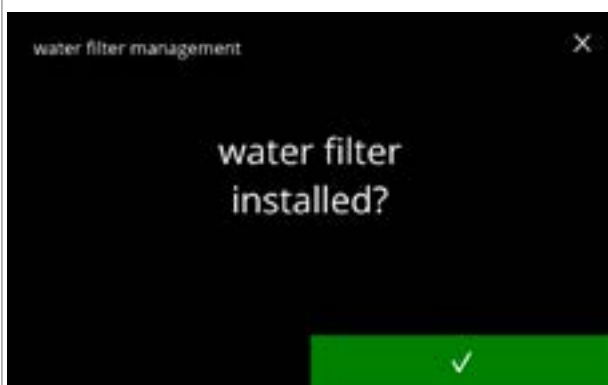

6.1.3b

- Confirmation screen:
- install the water filter (conform its instructions)
 - press **✓** to confirm and go to screen [6.1.3f](#)

6.1.3c



Replacing:

- press “*replace water filter*” to select and go to the next screen
- press **◀** or **▶** to scroll through the water filter sub-menu
 - » water filter settings ([6.1.3e](#))
 - » uninstall water filter ([6.1.3h](#))

6.1.3d

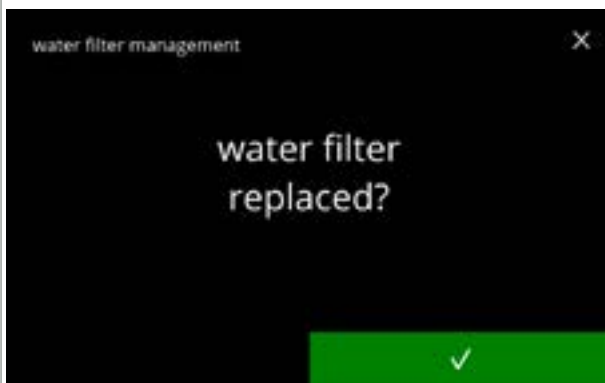

Replace the water filter (according to its own instructions).

- press **✓** to confirm and go to screen [6.1.3f](#)

6.1.3e



Set notification:

- press “*water filter settings*” to select and go to the next screen
- press **◀** or **▶** to scroll through the water filter sub-menu
 - » uninstall water filter ([6.1.3h](#))
 - » replace water filter ([6.1.3c](#))

6.1.3f

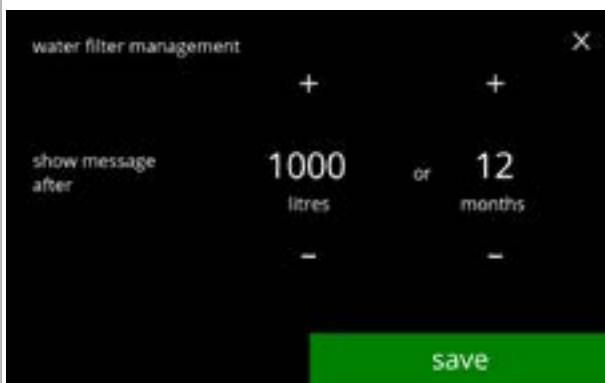

Set the “*replace water filter*” message:

- ▶ When the water filter is first installed, both values start at 0 and must be changed before **save** is shown.
- ▶ When replacing a water filter, the previous values are set and **save** is shown immediately.
- press **+** or **-** when the message should appear
 - ▶ Both values are required
- press **save** to confirm

Information screens:

- screen [6.1.3](#) is displayed after a few seconds

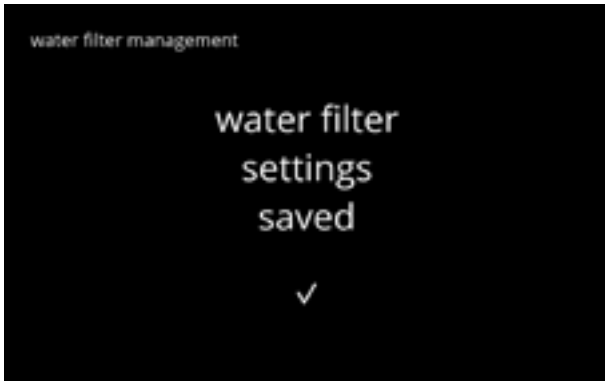

6.1.3g



6.1.3h

Permanent removal:

- press "uninstall water filter" to select and go to the next screen
- press **◀** or **▶** to scroll through the water filter sub-menu
 - » replace water filter ([6.1.3c](#))
 - » water filter settings ([6.1.3e](#))



6.1.3i

Uninstall the water filter:

- physically remove the water filter
- press **✓** to confirm

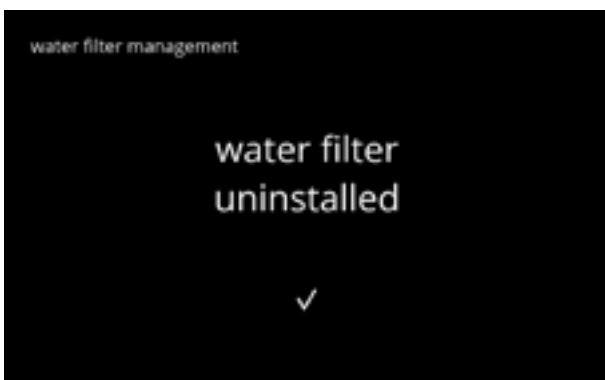

6.1.3j

Information screen:

- screen [6.1.3](#) is displayed after a few seconds

6.1.4 Hot-key rinsing function

To prevent clogging, it is necessary to rinse the mixing system several times a day. For this purpose, it is possible to set up a so-called hot-key on the screen.

In this menu it is possible to put the hot-key rinsing function active or inactive in the beverage selection screen.

Default: OFF

- ▶ To use the hot-key rinsing function press and hold for five seconds the S M L button on the beverage selection screen, the rinsing of the mixing system starts immediately.

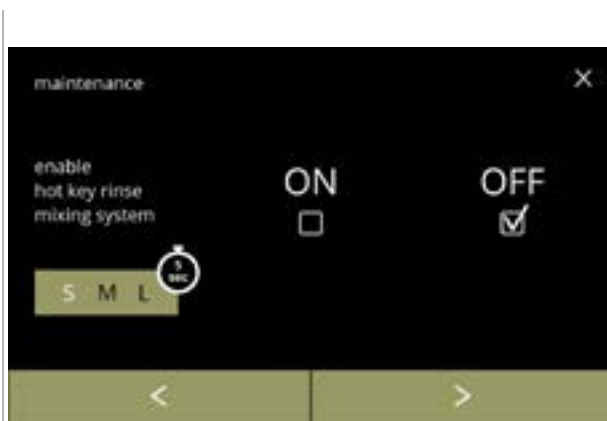
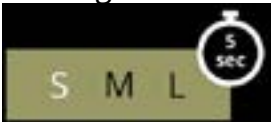

Availability of hot-key:

- press the checkbox below "ON" to make the hot-key visible
- press **<** or **>** to scroll through the maintenance menu

6.1.4



Setting the hot-key:

- press **save** to confirm

- ▶ *Save is only active if something has changed.*

6.1.4a

6.1.5 Cleaning management

In this menu, it is possible to set a time for a cup counter to display a warning before rinsing the machine.

The warning can always be cancelled without rinsing the machine.

Default: ON

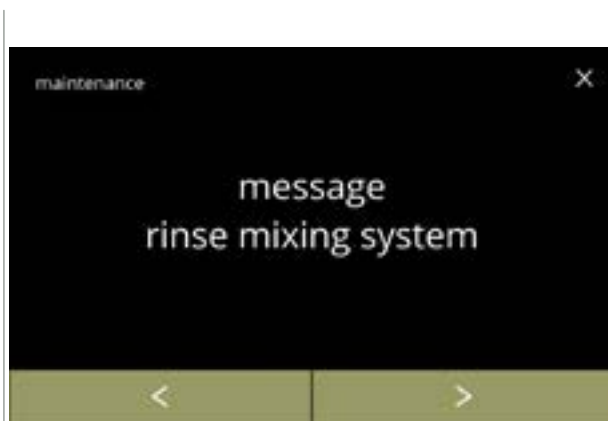

6.1.5

Cleaning management

- press "message rinse mixing system" to select
- press **◀** or **▶** to scroll through the maintenance menu

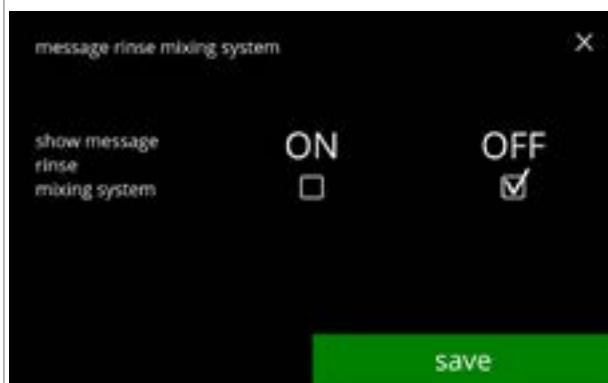

6.1.5a

Setting rinse message:

- press the checkbox to set the message
 - » select OFF and **save**: go to the next screen
 - » select ON and **✓**: go to screen [6.1.5c](#)



6.1.5b

Information screen:

- screen [6.1.5](#) is displayed after a few seconds

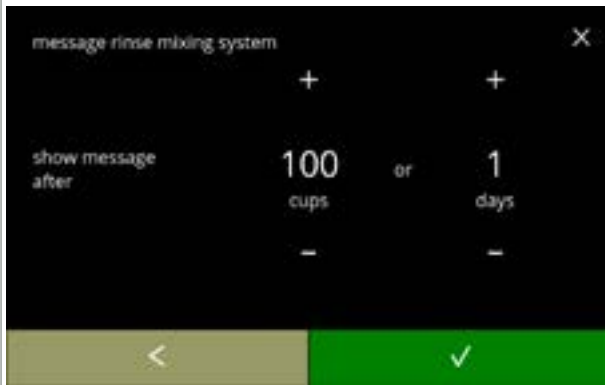

6.1.5c

Set day or time:

- press **+** or **-** to set the number of cups or days after which the warning should pop-up
- press **✓** to confirm and go to the next screen
- press **←** to go back to screen [6.1.5a](#)

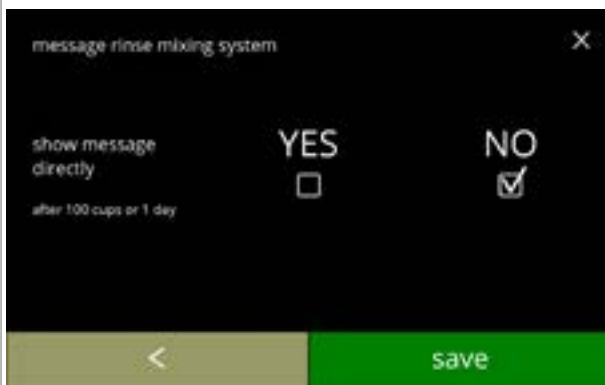

6.1.5d

Message direct or at a later time:

- press the checkbox to set the message timing:
 - » select YES and **save**: go to the second screen of [6.1.5f](#)
 - » select NO and **✓**: go to the next screen
- press **←** to go to the previous screen

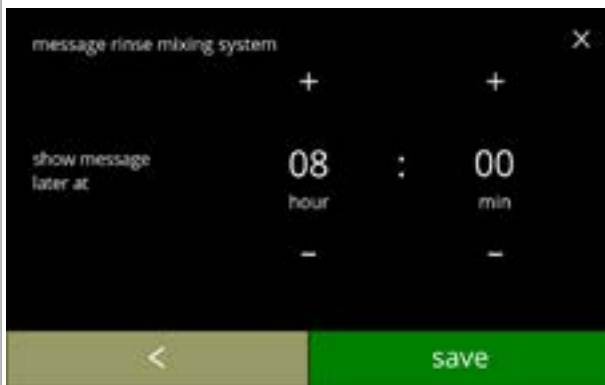

6.1.5e

Set the timer:

- press **+** or **-** to set the hour and minutes
- press **save** to confirm and go to the first screen of [6.1.5f](#)
- press **←** to go to the previous screen

Information screens:

- screen [6.1.5](#) is displayed after a few seconds



6.1.5f



6.1.6 Descale management

It is important to know the correct hardness of the water at the location where the Bolero is used (for setting the descaling signal).

If necessary, ask the local water company for the hardness of the water supplied or measure the hardness of the water supplied on site with a water hardness tester (according to the corresponding instructions).

Default: ON (with average water hardness)

See also [§8.1 on p.138](#).



Descale management

- press "descale management" to confirm
- press **◀** or **▶** to scroll through the maintenance menu

Descale message:

- press *the checkbox* to set the message
 - » select OFF and **save**: go to the next screen
 - » select ON and **✓**: go to screen [6.1.6c](#)

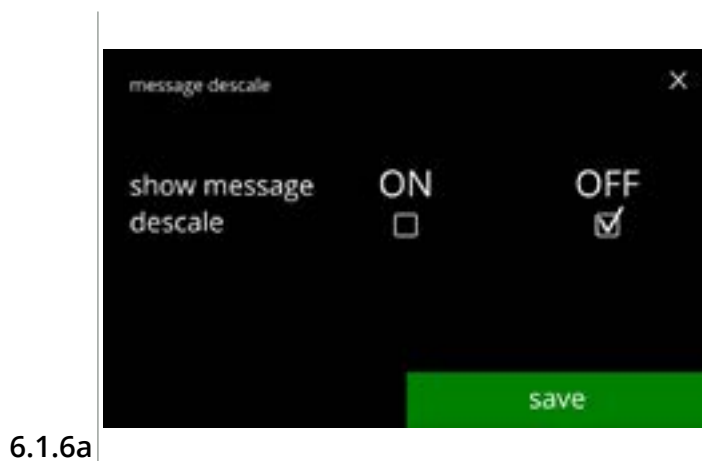

Information screen:

- screen [6.1.6](#) is displayed after a few seconds



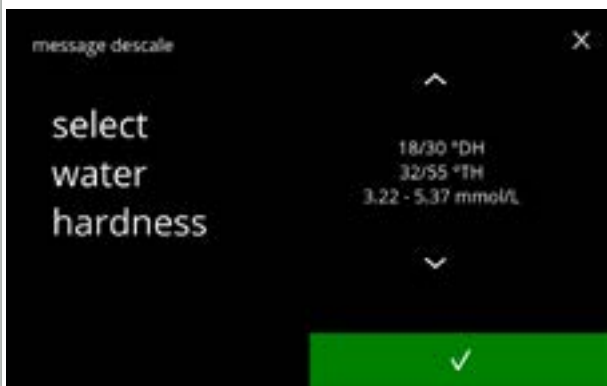

6.1.6c

Water hardness:

- press **▲** or **▼** to set the water hardness
 - ▶ *When a water filter is used, the message can be delayed, select 0-4 °DH.*
 - » select a value between 4/8 and 18/30 °DH; press **✓** to confirm and go to screen [6.1.6g](#)
 - » select 0/4 °DH; press **✓** to confirm and go to the next screen

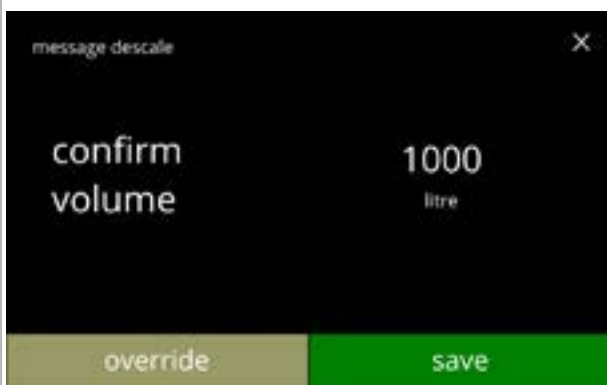

6.1.6d

Volume override:

- press **save** to confirm and go to screen [6.1.6h](#)
- press **override** to adjust the volume for the notification and go to the next screen
 - ▶ *When a water filter is used the volume can be adjusted.*

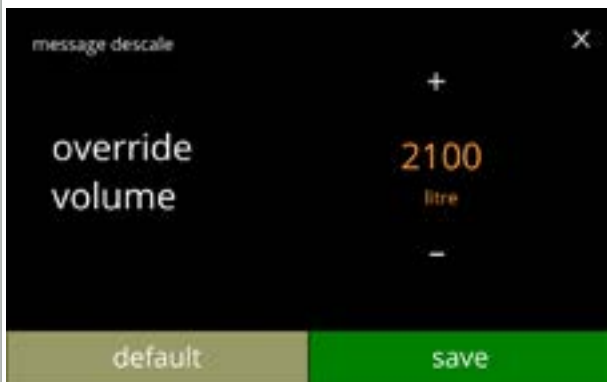

6.1.6e

Increase maximum standard volume:

- press **+** or **-** to set the volume
- press **save** to confirm and go to the next screen
- press **default** to go to the previous screen
 - ▶ *The override volume is shown in orange and can be set from 2100 till 9999 litre.*
 - ▶ *If used incorrectly, the descale message can be delayed for too long, allowing lime-scale to build up.*



6.1.6f

Information screen:

- screen [6.1.6](#) is displayed after a few seconds



Standard volumes/water hardness:
• press **save** to confirm and go to the next screen

6.1.6g



Information screen:
• screen [6.1.6](#) is displayed after a few seconds

6.1.6h

6.1.7 Canister calibration

In this menu the canisters can be calibrated.

The calibration determines the quantity of the ingredient when a canister motor runs at a defined speed for a defined time.

When finished the measured weight must be filled in.



Necessities:

- empty cup
- precision scale



6.1.7

Canister calibration procedure:

- press "canister calibration" to confirm
- press  or  to scroll through the maintenance menu

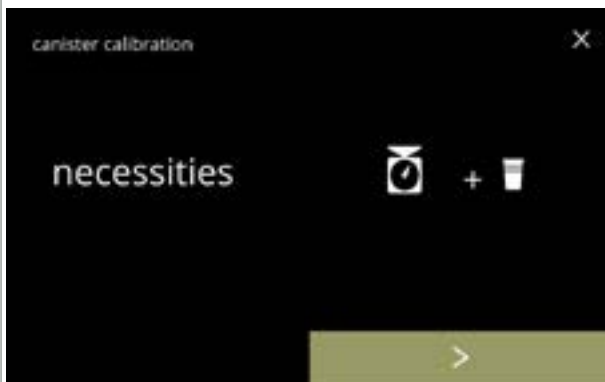

6.1.7a





Make sure all necessities are available.

- press  to go to the next screen



6.1.7b

Canister selection:

- ▶ *The number of canisters may vary per configuration, see [§8.3 on p.139](#).*
- press  or  to select a canister
- press  to confirm and go to the next screen
- press  to go to the next screen
- press  to go to the previous screen

Information screen:

- turn the fixation ring counter-clockwise
- remove the complete mixing system and the condense reservoir
- press **✓** to confirm and go to the next screen
- press **◀** to go to the previous screen

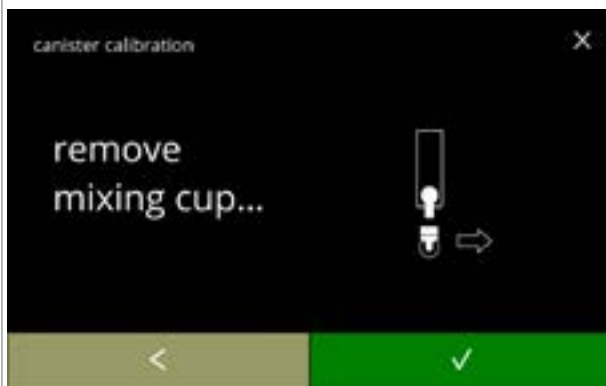

6.1.7c

Information screen:

- ▶ *Tare your precision scale with an empty dry cup*
- put an *empty dry* cup under the canister outlet
- press **start** to begin the pre-calibration dosing
- press **◀** to go to the previous screen

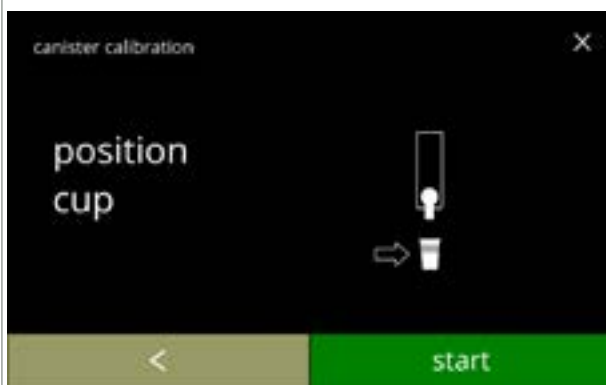

6.1.7d

Pre-calibration dosing:

- wait for the next screen

- ▶ *The canister motor will turn to fill up the outlet.*

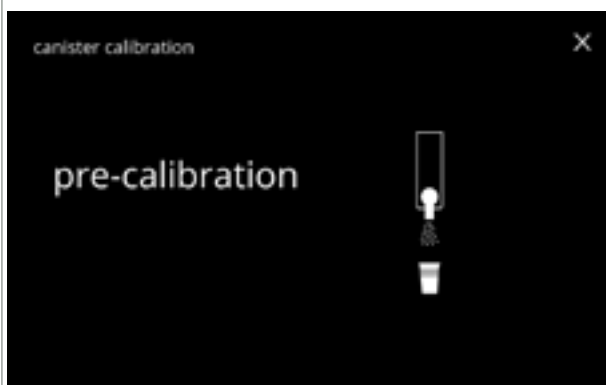

6.1.7e

Pre-calibration dosing:

- throw the collected ingredient back into the canister
- press **✓** to confirm and go to the next screen
- press **◀** to go back to screen [6.1.7d](#)

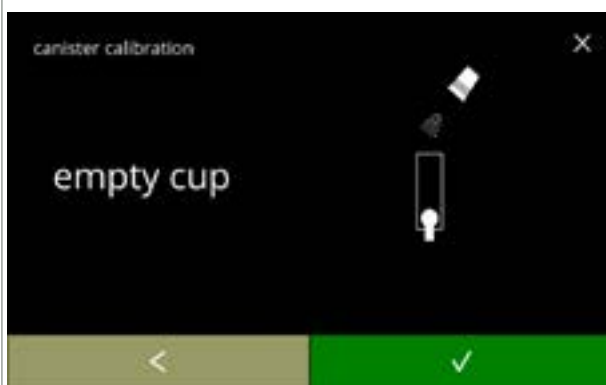

6.1.7f

6.1.7g

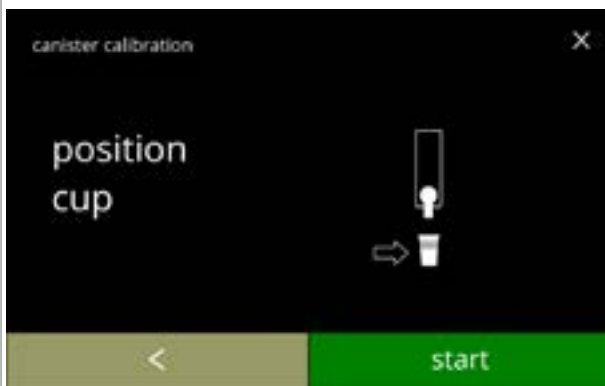

Actual calibration:

- put a *empty dry* cup on the balance to calibrate
- put the cup under the canister outlet
- press **start** to begin the dosing
- press **←** to go to the previous screen

6.1.7h

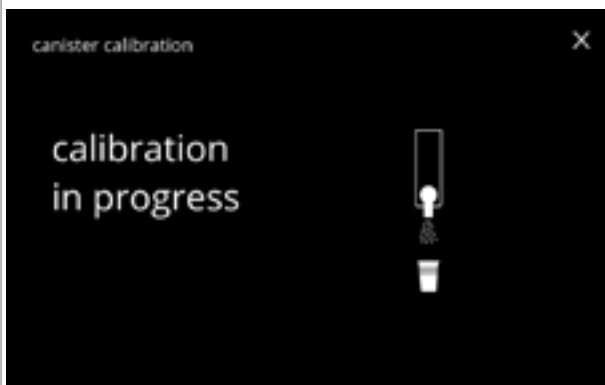

Dosing:

- wait for the next screen
- ▶ *The canister motor starts and stops several times.*

6.1.7i



Weighing the ingredient:

- put the cup with ingredient on the balance
- press **+** or **-** to enter the weight on the screen
- press **save** to confirm and go to the next screen
- press **←** to go back to screen [6.1.7f](#)

6.1.7j

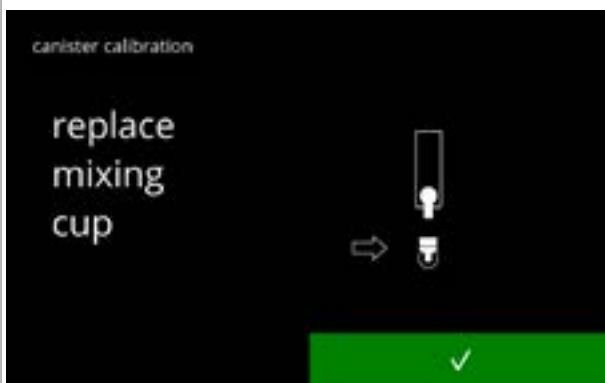

Calibration completed:

- put the mixing system back in place
- press **✓** to confirm

Information screens:

- screen [6.1.7](#) is displayed after a few seconds

6.1.7k



6.1.8 Pump calibration

In this menu the pump can be calibrated.

With calibration the volume of the water is determined for a defined flow and time.

When finished the measured volume must be filled in.

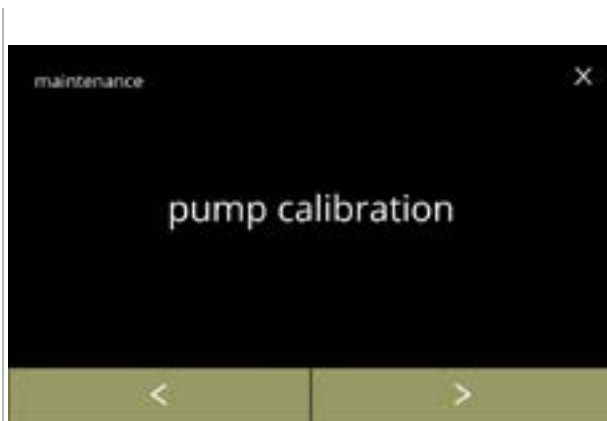

Necessities:

- measuring jug (minimal 200 ml)



6.1.8

Pump calibration procedure:

- press "pump calibration" to confirm
- press  or  to scroll through the maintenance menu

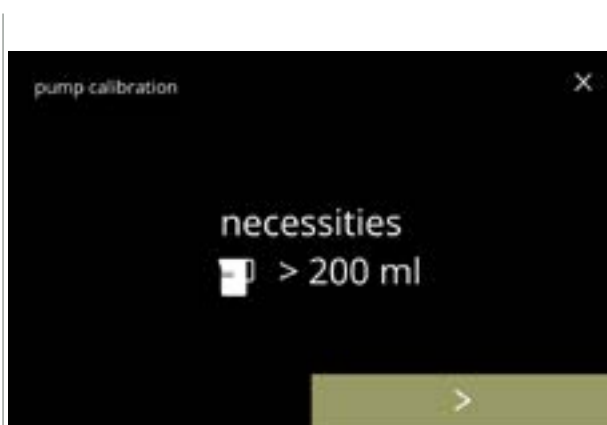

6.1.8a



Make sure all necessities are available.

- press  to confirm and go to the next screen



6.1.8b

Information screen:

- put the *empty* measuring jug under water outlet
- press  to begin the dosing
 - ▶ *Please note the machine dispenses hot water.*
- press  to go to the previous screen

Warning screen:



► *The warning screen is displayed for a few seconds.*

- wait for the next screen

6.1.8c

Hot water dosing in progress:

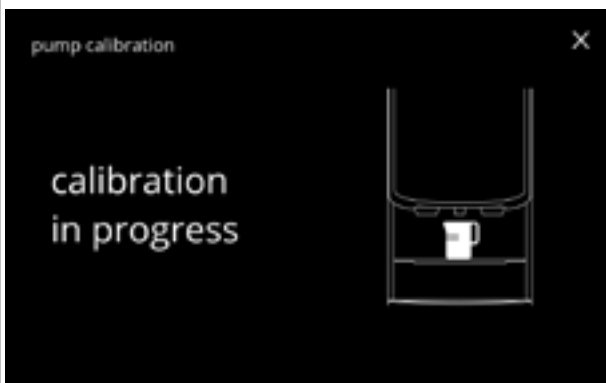

- wait for the next screen

► *Hot water from water outlet.*

6.1.8d

Determine volume:

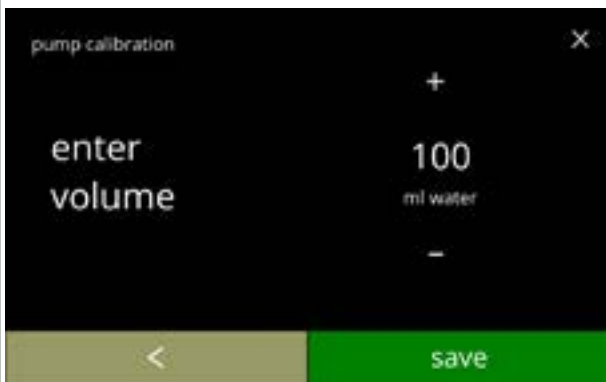

- read off the amount of water dosed
- press **+** or **-** to enter the volume on the screen
- press **save** to confirm and go to the next screen
- press **←** to go back to screen [6.1.8b](#)

6.1.8e

Information screens:

- screen [6.1.8](#) is displayed after a few seconds

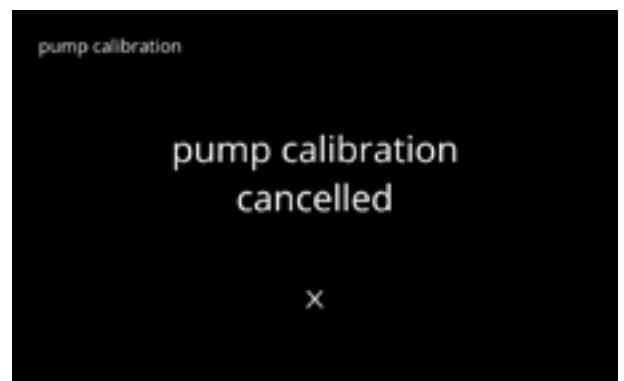
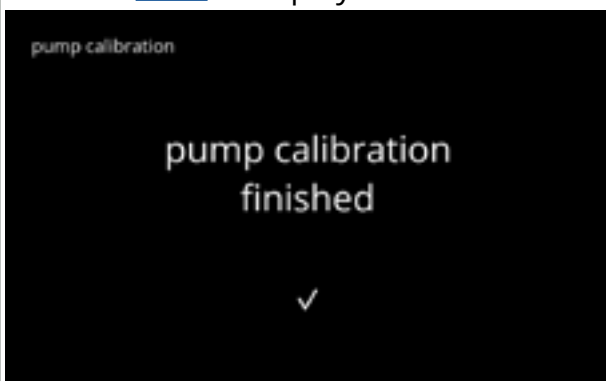

6.1.8f

6.1.9 Input test

For a proper fault analysis a diagnosis should be made first.
An input test can be performed for the following components:

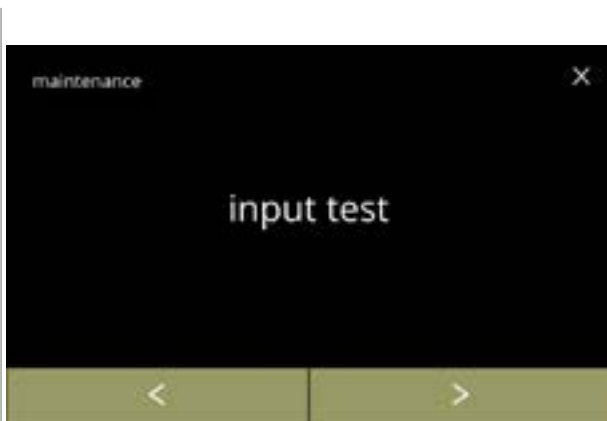

- touchscreen
- door switch / safety key
- float
- low pressure pump
- NTC1 (low position) and NTC2 (high position)
- Fliptray switch

► *Despite the fact that sufficient safety measures are taken working with the systems may entail risks. Our starting point is that people activating this menu are sufficiently skilled and therefore able to properly assess these risks with respect to safety.*



6.1.9

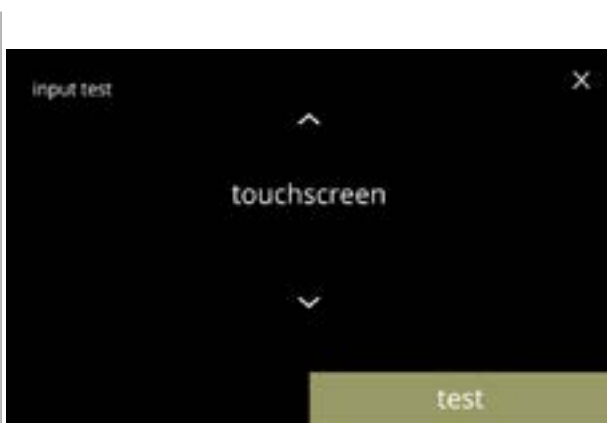

Input test

- press "input test" to confirm
- press  or  to scroll through the maintenance menu



6.1.9a

Select an input test:

- press  to go to the next screen
- press  or  to select another component

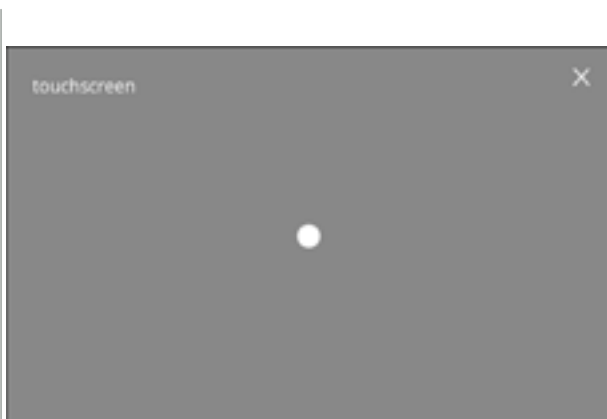

6.1.9b



Touchscreen:

- touch anywhere on the screen and the dot moves to the point of contact
- *Swiping is not available.*



6.1.9c

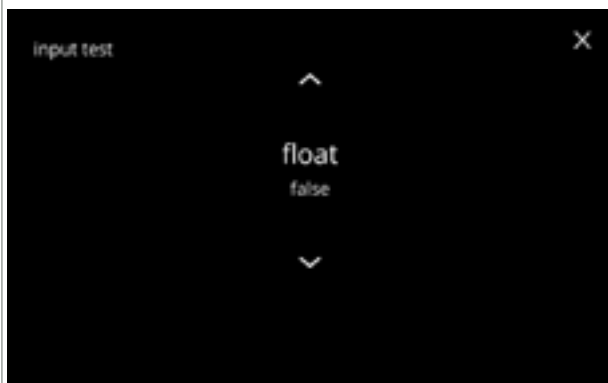

Door switch/safety key:

- remove the service key and replace it resulting in false/true
- press  or  to select another component



6.1.9d

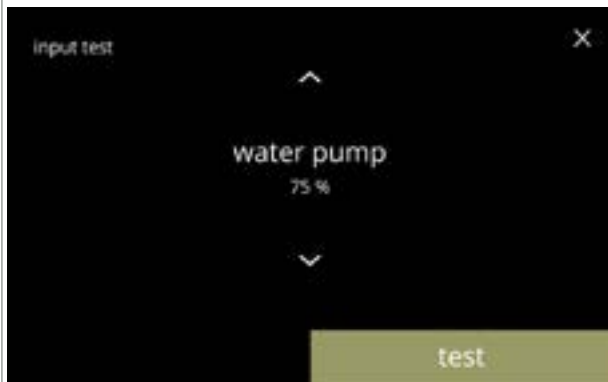

Float:

- shows current state on screen (true=wet or false=dry)
- press  or  to select another component



6.1.9e

Low pressure pump:

- shows current state of the sensor on screen
- press  to go to the next screen
- press  or  to select another component



6.1.9f

Test the low pressure pump:

- the low pressure pump is turned on for 10 seconds and then stops.
 - ▶ *The pump motor runs slowly, so no water will come out of the outlet.*
- press  to go back to previous screen



6.1.9g

NTC sensors:

- shows current temperature on screen
- press **test** to go to the next screen
- press **▲** or **▼** to select another component



6.1.9h

Test the NTC sensors:

- ▶ *The heating element is on for 10 seconds, so the temperature on the screen should change.*
- press **cancel** to go back to previous screen



6.1.9i

Fliptray switch:

- moving the fliptray is resulting in up/down
- press **▲** or **▼** to select another component

6.1.10 Output test

For a proper fault analysis a diagnoses should be made first.
The output test gives an overview of all parts able to deliver signals (electrical components).
Components that can be tested:

- buzzer
 - mixer motor
 - heating element
 - fan motor
 - canister motor
 - low pressure pump
 - magnetic inlet valve
 - water selector motor
- *Despite the fact that sufficient safety measures are taken working with the systems may entail risks. Our starting point is that people activating this menu are sufficiently skilled and therefore able to properly assess these risks with respect to safety.*

6.1.10

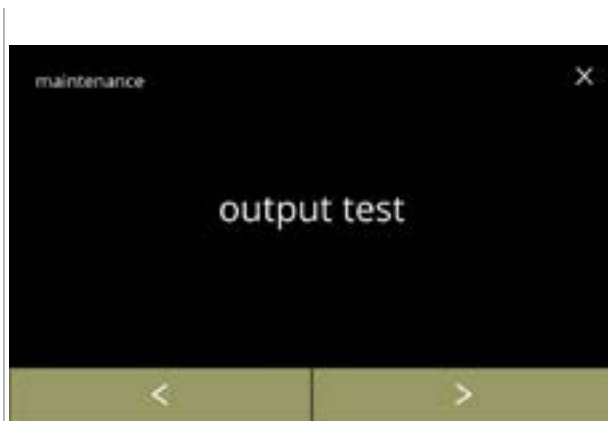

Output test

- press "output test" to confirm
- *There are two options for testing:*
 - » pulse: the action is executed as long as the button is pressed.
 - » cycle: the action is executed for 10 seconds and press on **cancel** to interrupt.
- press **◀** or **▶** to scroll through the maintenance menu

6.1.10a



Buzzer test:

- press **pulse**, result: short 'beep'
- press **cycle**, result: multiple short 'beeps'
- press **▲** or **▼** to select another component

6.1.10b

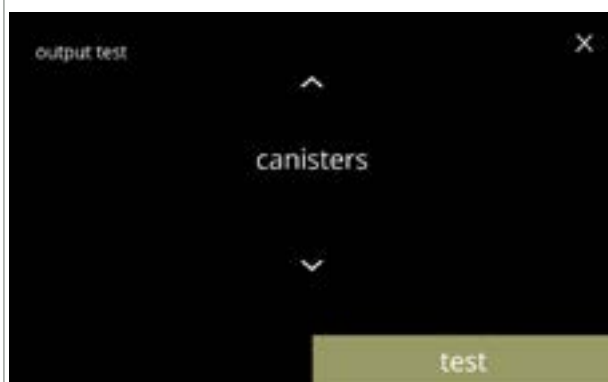

Canister motor test:

- press **test** to select a canister in the next screen
- *The number of canisters may vary per configuration, see [§8.3 on p.139](#).*
- press **▲** or **▼** to select another component

6.1.10c



Canister motor test:

- remove the canister(s)
- press **pulse**,
result: the canister motor runs briefly at 20% speed
- press **cycle**,
result: the canister motor runs at 20% speed for 10 seconds
- press **▲** or **▼** to select another canister

6.1.10d



Mixer motor test:

- press **test** to select a mixer in the next screen
- ▶ *The number of mixer motors may vary per configuration, see §8.3 on p.139.*
- press **▲** or **▼** to select another component

6.1.10e



Mixer motor test:

- press **pulse**,
result: the mixer motor runs briefly at full speed
- press **cycle**,
result: the mixer motor runs at full speed for 10 seconds
- press **▲** or **▼** to select another mixer

6.1.10f



Low pressure pump test:

- press **pulse**,
result: the pump motor runs briefly
- press **cycle**,
result: the pump motor runs for 10 seconds
- ▶ *The water will not reach the mixing cup.*
- press **▲** or **▼** to select another component



6.1.10g

Heating element test:

- press **pulse**,
result: the heating element turns on for a moment
- press **cycle**,
result: the heating element turns on for 10 seconds
- press **▲** or **▼** to select another component



6.1.10h

Magnetic inlet valve test:

- press **pulse**,
result: the valve opens for a moment
- ▶ *Do **not** perform the pulse test several times in a row, as this can lead to an overflow of the float tank, for this reason the cycle button is not accessible.*
- press **▲** or **▼** to select another component



6.1.10i

Fan motor test:

- press **pulse**,
result: the fan motor runs briefly at full speed
- press **cycle**,
result: the fan motor runs at full speed for 10 seconds
- press **▲** or **▼** to select another component



6.1.10j

Water selector test:

- press **test** to select a position of the water selector in the next screen
- ▶ *The number of positions depends, among other things, on the number of mixing systems, see [§8.3 on p.139](#).*
- press **▲** or **▼** to select another component



Water selector positions test:

- press **pulse**,
result: the selector runs from the hot water (position 0) to the selected position and back
- press **cycle**,
result: the selector runs from the hot water (position 0) to the selected position, press **cancel** to return
- press **▲** or **▼** to select a different position

6.1.10k

6.1.11 Cleaning instructions

To maintain proper functioning, the Bolero must be cleaned regularly.

weekly	monthly
<ul style="list-style-type: none"> • drip tray • mixing system • the outside • the inside 	<ul style="list-style-type: none"> • canister(s) • ventilation system

► The cleaning instructions are also available as an animation by scanning the QR code in this menu.

► See also [chapter 5. Cleaning on p.12](#) for a detailed description.

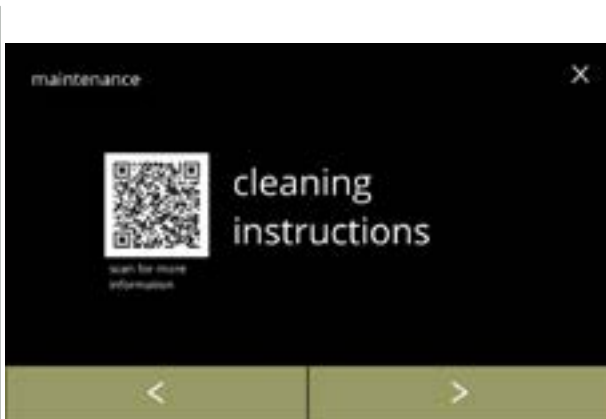

Cleaning instructions:

- press "cleaning instructions" to confirm
- press ◀ or ▶ to scroll through the maintenance menu

6.1.11

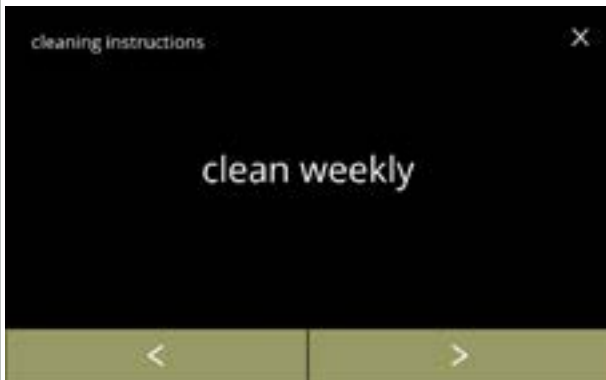

Weekly cleaning instructions:

- press "clean weekly" to go to the next screen
- For detailed instruction see [§5.1 on p.12](#).
- press ◀ or ▶ to go to monthly cleaning ([6.1.11f](#))

6.1.11a



Cleaning the drip tray:

- follow the instructions on the screen
- press ◀ or ▶ to select another daily cleaning instruction

6.1.11b



Cleaning the mixing cups:

- follow the instructions on the screen
- press **◀** or **▶** to select another daily cleaning instruction

6.1.11c



Cleaning the outside:

- follow the instructions on the screen
- press **◀** or **▶** to select another weekly cleaning instruction

6.1.11d



Cleaning the inside:

- follow the instructions on the screen
- press **◀** or **▶** to select another weekly cleaning instruction

6.1.11e

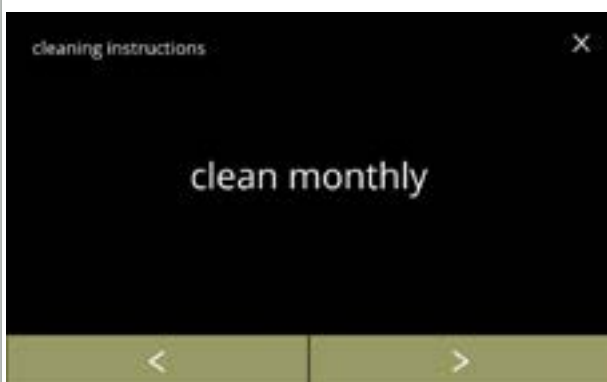

Monthly cleaning instructions:

- press "clean monthly" to go to the next screen
- ▶ For detailed instruction see [§5.2 on p.14.](#)
- press **◀** or **▶** to go to daily cleaning ([6.1.11a](#))

6.1.11f



6.1.11g

Cleaning the canisters:

- follow the instructions on the screen
- press **◀** or **▶** to select another weekly cleaning instruction

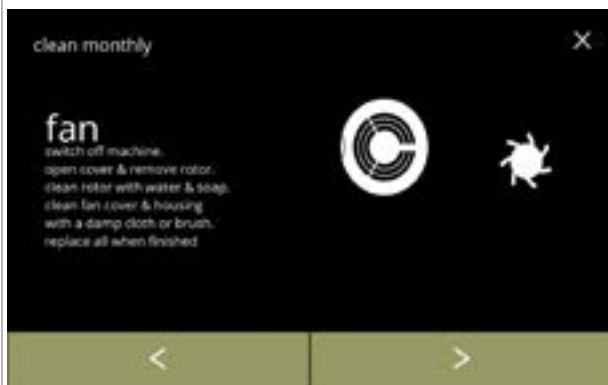

6.1.11h

Cleaning the fan:

- follow the instructions on the screen
- press **◀** or **▶** to select another weekly cleaning instruction

6.1.12 Counters

The counters tell you how many beverages have been prepared for cups and decanters. A total counter of all issued beverages is also shown.

If a drink is removed, the number of that beverage is still counted in the total machine counter.

6.1.12

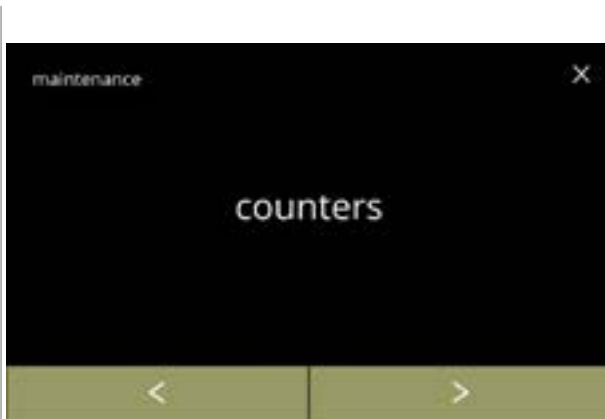

Counters readings:

- press "counters" to select
- press **◀** or **▶** to scroll through the maintenance menu

► *The counters sub-menu consists of the following:*

- » day/total counters [6.1.12a](#)
- » reset day counters [6.1.12c](#)
- » reset all counters [6.1.12g](#)
- » export counters [6.1.12k](#)
- » machine counter [6.1.12o](#)

6.1.12a



Day counters:

- press "day/total counters" to select
- press **◀** or **▶** to scroll through the counters sub-menu

6.1.12b



Information screens of the day counters per beverage and the total of all beverages:

- press **▲** or **▼** to scroll through all available beverages
- press **◀** to go the previous screen

► *A visual distinction is made between beverages per cup or pitcher.*



6.1.12c

Reset all day counters:

- press "reset all day counters" to select
- press **◀** or **▶** to scroll through the counters sub-menu



6.1.12d

Start reset:

- press **reset day counters** to confirm the reset of all day counters



6.1.12e

Confirmation screen:

- press **✓** to confirm and continue the reset of all day counters
- press **✗** to cancel and go to the previous screen

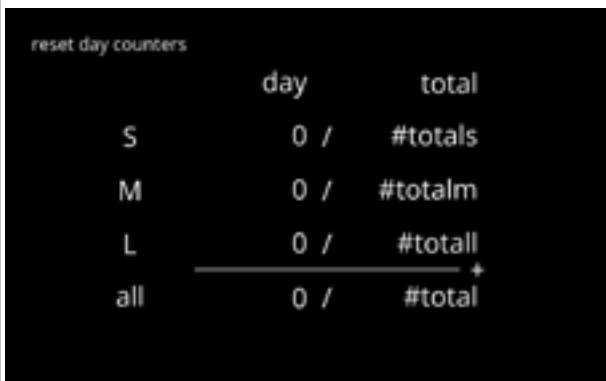

6.1.12f

Information screen:

- screen [6.1.12c](#) is displayed after a few seconds



Total counters:

- press "total counters" to select
- press **◀** or **▶** to scroll through the counters sub-menu

6.1.12g



Start reset:

- press **reset all counters** to confirm the reset of all counters

6.1.12h

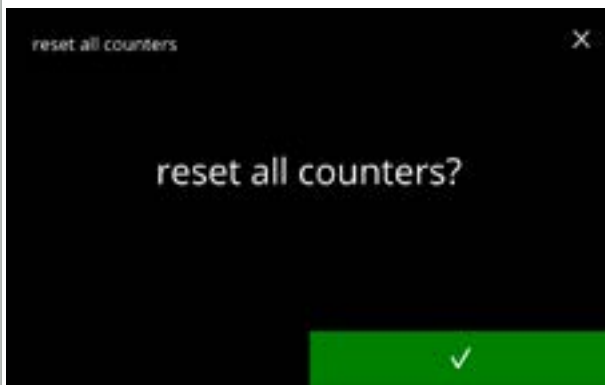

Confirmation screen:

- press **✓** to confirm and continue the reset of all counters
- press **✗** to cancel and go to the previous screen

6.1.12i

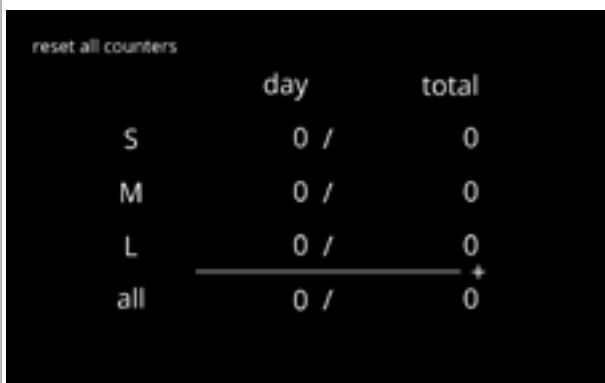

Information screen

- screen [6.1.12g](#) is displayed after a few seconds

6.1.12j



6.1.12k

Export counters:

- place a USB stick
 - ▶ *If there is no USB stick in the machine this option is greyed out.*
- press "export counters" to confirm
- press **←** or **→** to scroll through the counters sub-menu

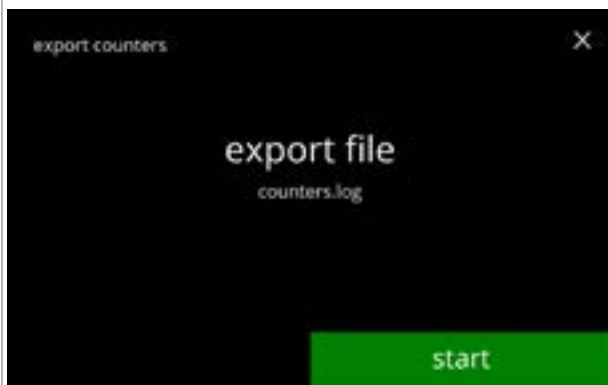

6.1.12l

Start export counters:

- press **start** to begin the export



6.1.12m

Progress screen

- wait for the process to finish
- press on **cancel** to interrupt

Information screens:

- screen [6.1.12k](#) is displayed after a few seconds

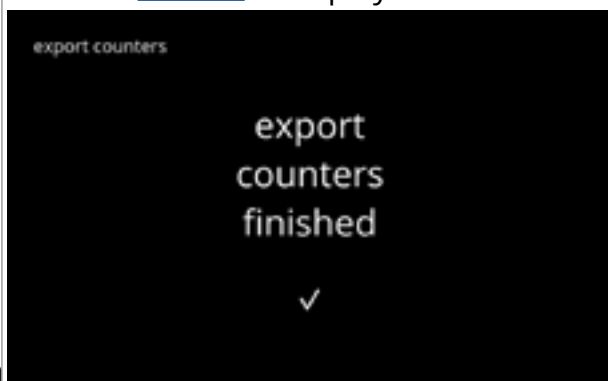

6.1.12n



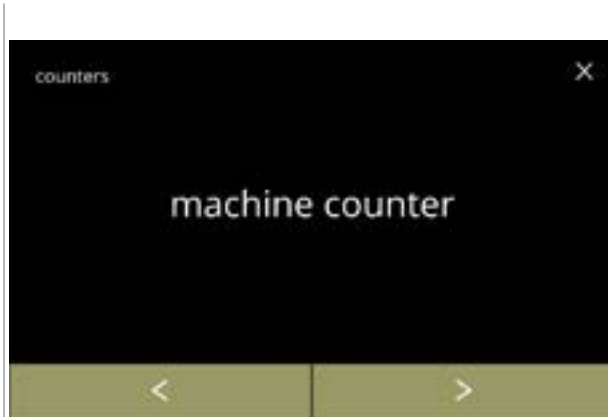

Machine total counter:

- press "machine counter" to select
- press ◀ or ▶ to scroll through the counters sub-menu

6.1.12o



Information screen:

- screen [6.1.12o](#) is displayed after a few seconds

6.1.12p

6.1.13 Maintenance history

This menu shows the maintenance history.
The following is shown with date and time:

- rinse the mixing system
- descale
- water filter (where the specific action install, replace or remove is listed above the time and day)

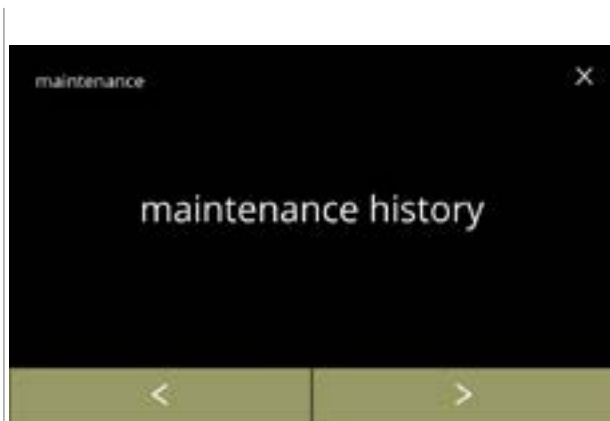

Maintenance history:

- press "Maintenance history" to confirm
- press ◀ or ▶ to scroll through the maintenance menu

6.1.13



Information screen (rinse):

- press ▲ or ▼ to retrieve the rinse history
- press ◀ or ▶ to scroll through the maintenance history

6.1.13a





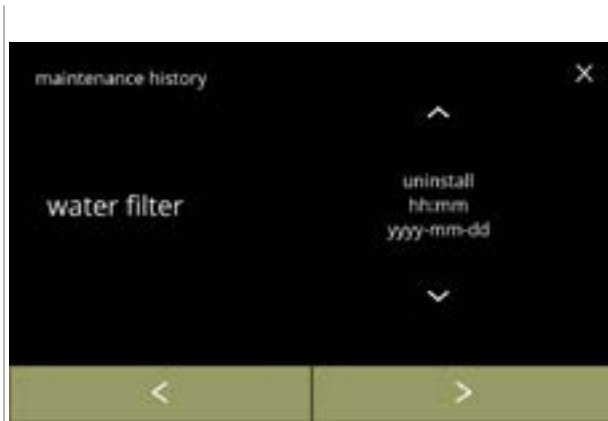

Information screen (descale):

- press ▲ or ▼ to retrieve the descale history
- press ◀ or ▶ to scroll through the maintenance history

6.1.13b



- Information screen (water filter):
- press  or  to retrieve the filter history
 - press  or  to scroll through the maintenance history

6.1.13c

6.2 Beverage menu

The beverage menu contains all functions to adjust your beverages to your wishes. Select one of the available options:

- press **◀** or **▶** to select the next option of the “beverage menu”
- press the “text area” to select the next level for that menu
- press **✕** to go back to [chapter 6. Programming menu on p.17](#)

► *The beverages, recipes and settings used are only examples.*

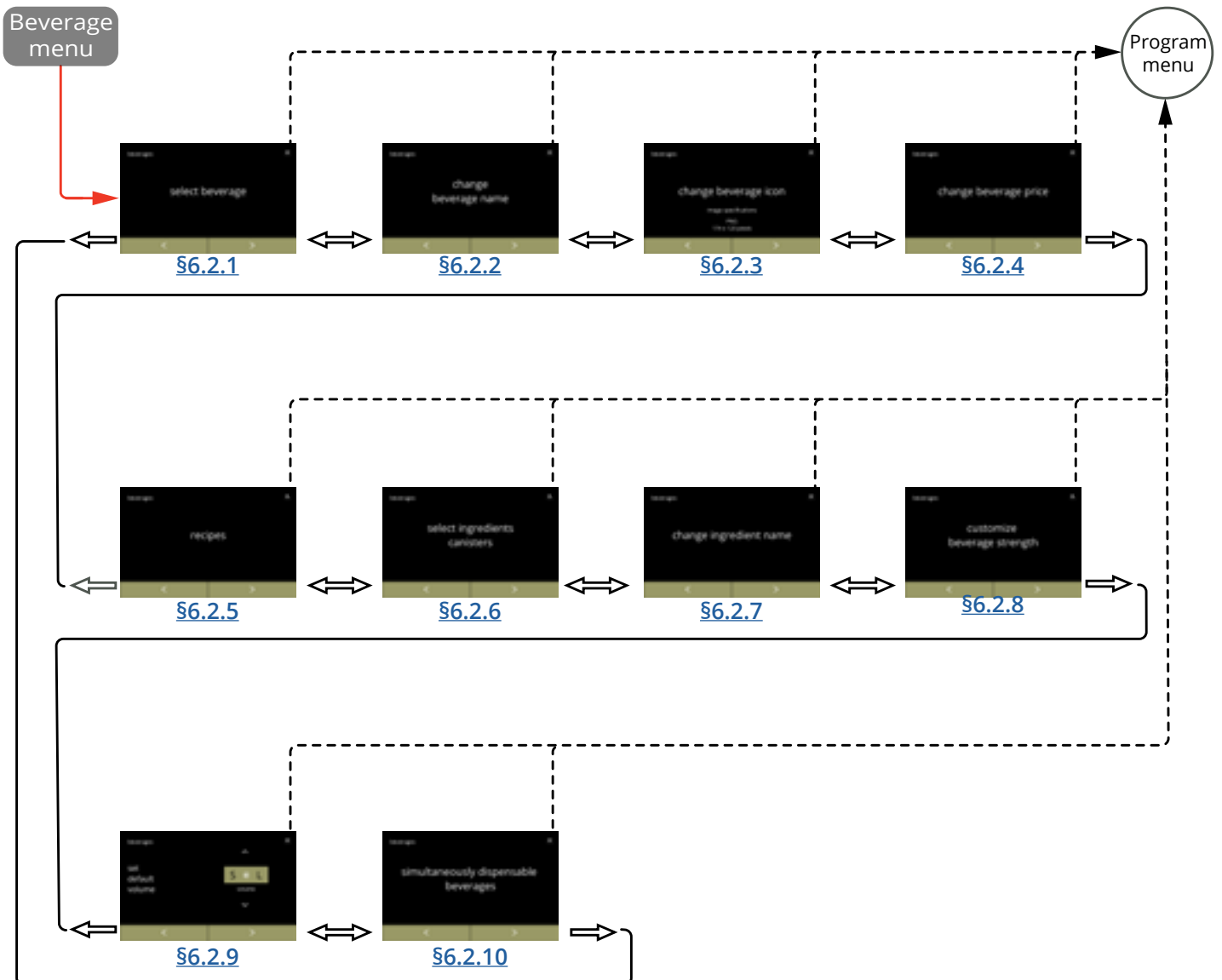

6.2.1 Add beverage to screen

In this menu the available beverages (recipes) can be selected and linked to a beverage position.

It is possible to replace a beverage, the beverages cannot be dragged to another place. The open spaces where another beverage can be placed are marked with 3 dots.

► *The beverages available will vary depending on the ingredients selected in the canisters.*

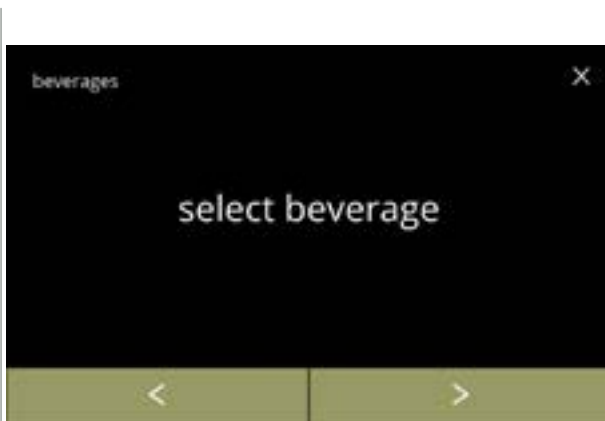

6.2.1

Place a beverage in the beverage selection screen:

- press "select beverage" to confirm
- press ◀ or ▶ to scroll through the beverage menu

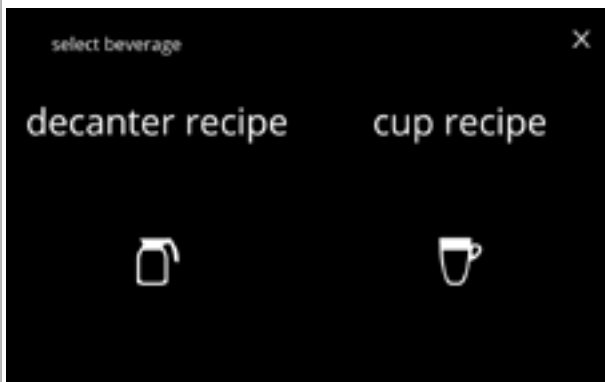

6.2.1a

Select the first subdivision:

- press 'decanter beverage' or 'cup beverage' and go to the next screen



6.2.1b

Available beverages in the beverage selection screen:

- press on a beverage to replace or a free place (marked as 3 dots) to add a beverage
- press **exit** to accept the current configuration and go to the previous screen

► *The beverages that are available will depend on the ingredients in the canisters and where the canisters are placed.*

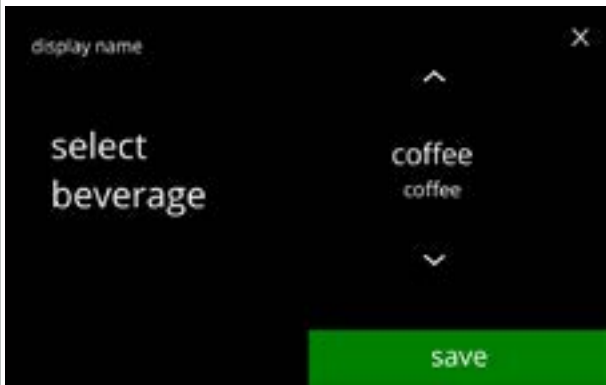

Replace or delete a beverage on the screen

► *Delete is active as long as the beverage names are the same.*

- press **delete** to remove the beverage (three dots now replace the beverage) or
- press **▲** or **▼** to select another beverage
- press **save** to replace the beverage

► See [§6.2.10 on p.91](#) which beverage can be dispensed at the same time.

6.2.1c

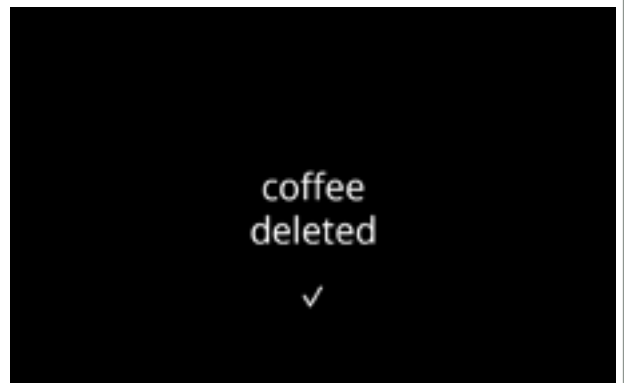
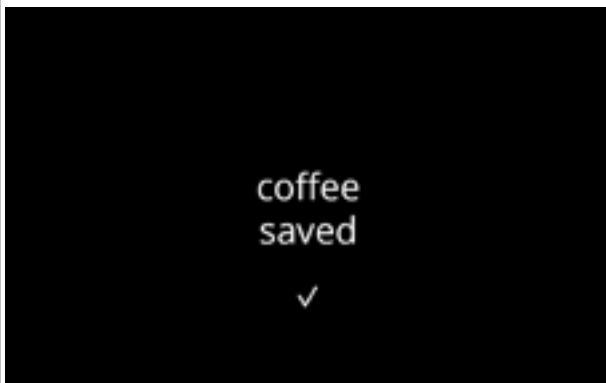

6.2.1d

6.2.2 Change beverage name

In this menu the name of the beverage can be changed to a custom defined beverage name.



6.2.2

Change beverage name:

- press "change beverage name" to confirm
- press **◀** or **▶** to scroll through the beverage menu

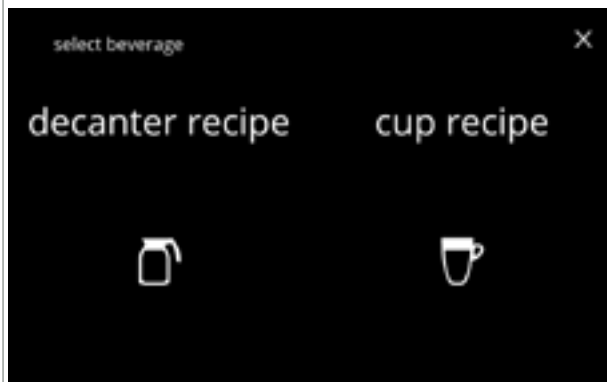

6.2.2a

Select the first subdivision:

- press 'decanter beverage' or 'cup beverage' and go to the next screen



6.2.2b

Available beverages in the beverage selection screen:

- press on a beverage to change the name
- press **exit** to accept the current configuration and go to the previous screen
- ▶ If the buttons **◀ ▶** are visible, multiple screens with beverages are available.

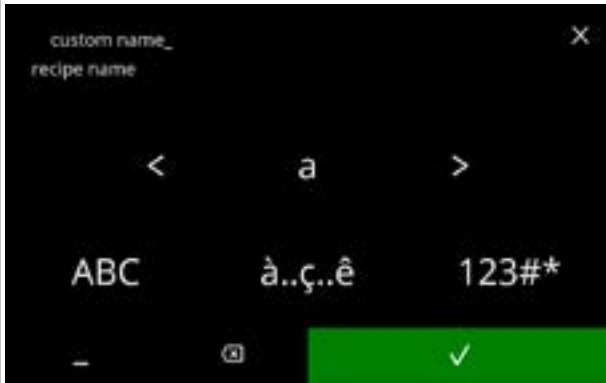

Enter the new custom beverage name:

- press **<** or **>** to scroll through the alphabet
- press the character between the **<** **>** to form the new beverage name
 - » press **ABC** for capitals
 - » press **à..ç..ê** for special characters
 - » press **123#*** for numbers
 - » press for a space
 - » press **⊗** to remove a previous input
- press **✓** to confirm the new beverage name

6.2.2c

Information screens:

- screen [6.2.2](#) is displayed after a few seconds

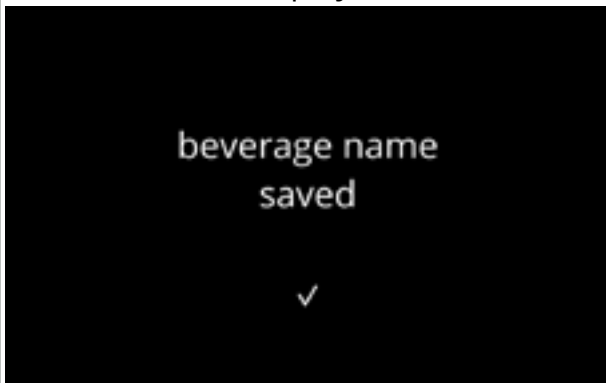

6.2.2d

6.2.3 Change beverage icon

In this menu, the beverage icon can be changed to a custom beverage icon associated with the selected beverage.

- ▶ *The standard beverage icons remain always available.*
- ▶ *We recommend to use a transparent background.*

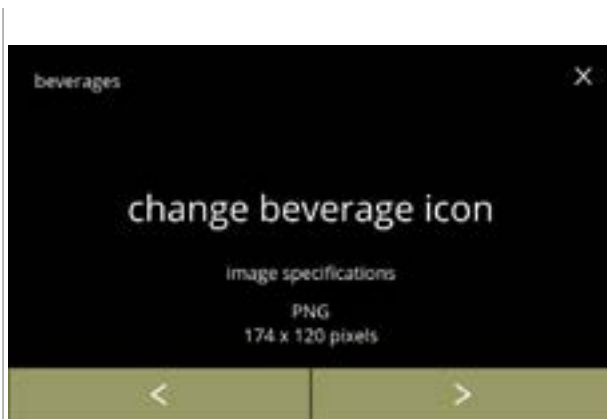

6.2.3

Change beverage icon:

- press "change beverage icon" to confirm
- press **◀** or **▶** to scroll through the beverage menu
- ▶ *Only files that meet the specifications can be loaded successfully.*

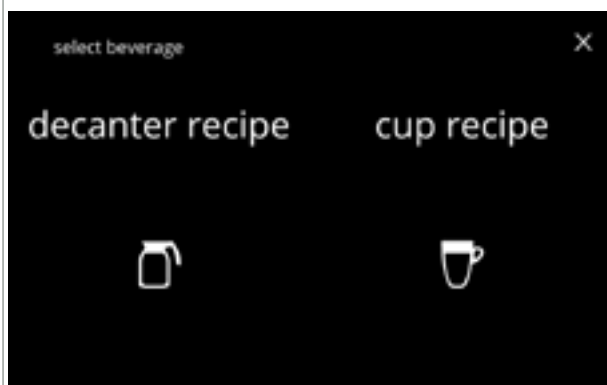

6.2.3a

Select the first subdivision:

- press 'decanter beverage' or 'cup beverage' and go to the next screen



6.2.3b

Available beverages in the beverage selection screen:

- press on a beverage to change the icon
- press **exit** to accept the current configuration and go to the previous screen
- ▶ *If the buttons **◀ ▶** are visible, multiple screens with beverages are available.*

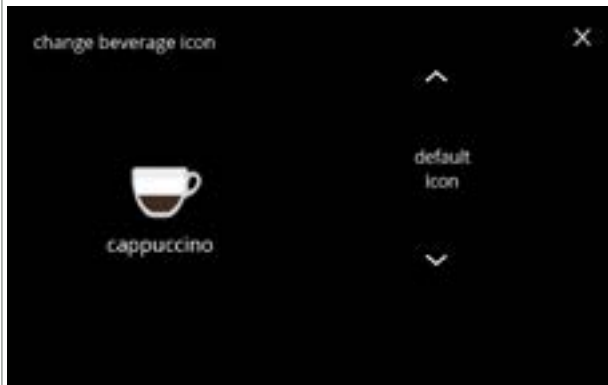

- Beverage icon (back to default / change):
- place a USB stick to select a new beverage icon
 - ▶ *Select customer-specific beverage icons or download the Bolero beverage icons set from our website onto a USB stick.*
 - press **▲** or **▼** to scroll through the options
 - press **save** to confirm

6.2.3c

Information screens:

- screen [6.2.3](#) is displayed after a few seconds

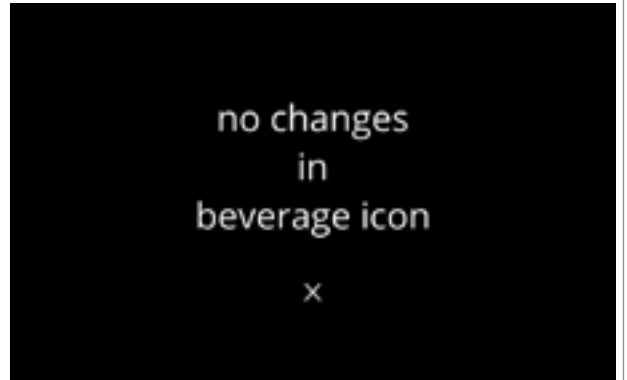
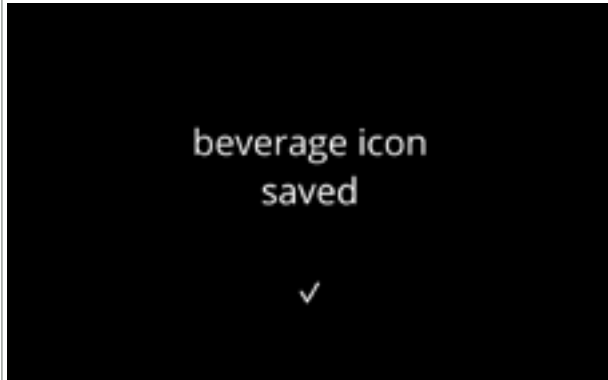

6.2.3d

6.2.4 Change beverage price

In this menu the price per beverage can be set or modified.

Prices can be a token or a currency.

Price can be set per cup type (cup, mug, decanter).

- ▶ Coins to be used are specified in [§6.3.11 on p.110](#).
- ▶ The currency symbol and the currency separator are determined by the external payment system

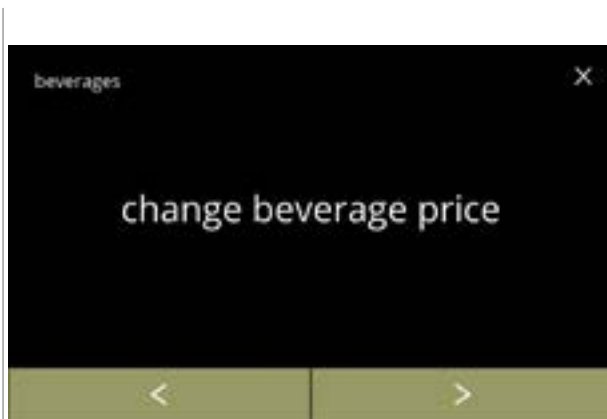

6.2.4

Change beverage price:

- press "change beverage price" to confirm
- press **◀** or **▶** to scroll through the "Beverage menu"

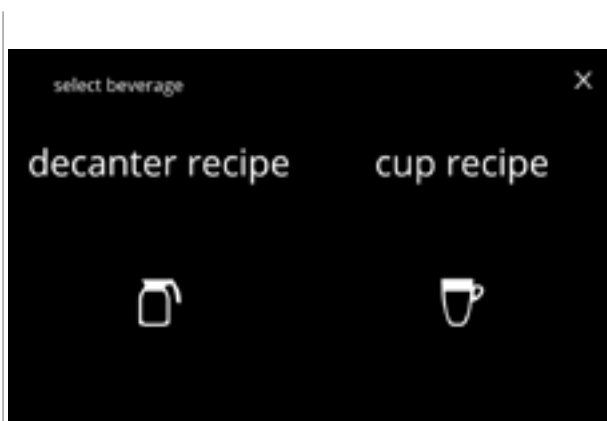

6.2.4a

Select the subdivision:

- press 'decanter beverage' or 'cup beverage' and go to the next screen



6.2.4b

Select a beverage:

- press on a beverage to change
- press **◀** or **▶** to go to the next screen with beverages (if available)
- press **exit** to accept the current beverage prices and go to the previous screen

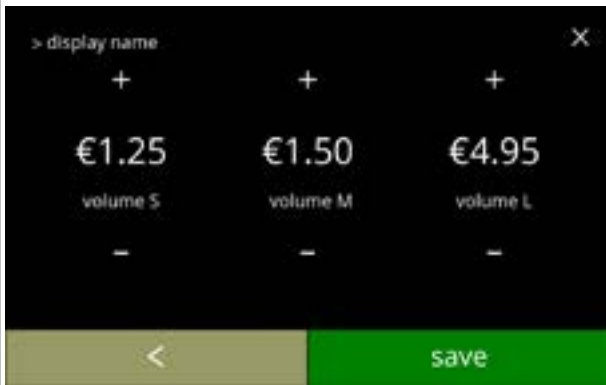

- Select a beverage volume price:
- press **+** or **-** to change beverage volume price
 - press **save** to go to the previous screen

6.2.4c

Information screens:

- screen [6.2.4a](#) is displayed after a few seconds

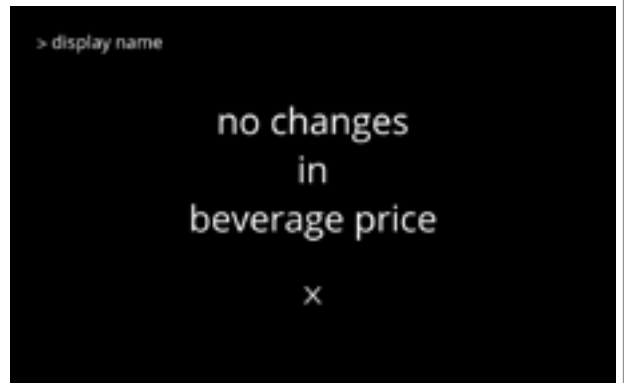
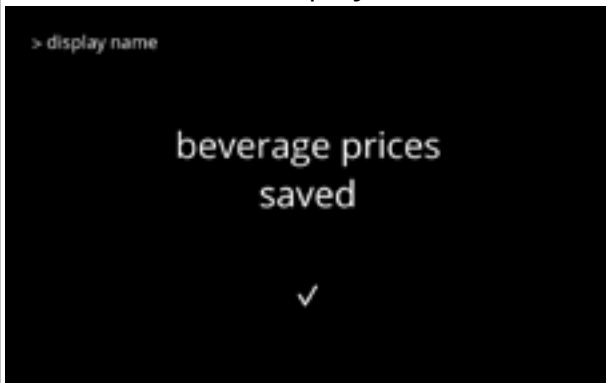

6.2.4d

Example screen prices



6.2.4e

Example screen tokens



- ▶ A token is only available if the payment device is programmed correctly.

6.2.4f

6.2.5 Recipes

In this menu the recipes of the beverage can be changed.

recipe editor basic	recipe editor expert
<ul style="list-style-type: none"> • volume • strength • mixer speed 	<ul style="list-style-type: none"> • volume • strength • ratio affected by strength • water ratio ingredients • mixer speed

- ▶ Only use ingredients that are suitable for vending machines and use the recommended dosage as indicated on the packaging.
- ▶ With the **recipe editor** a standard recipe can be changed (new recipes cannot be added here)
- ▶ A changed standard recipe can be reset to the default values via the recipe test, see [6.2.5av on p.82](#).
- ▶ With the **recipe builder**, a recipe can be created from scratch using the “create new recipe” option. Also a standard recipe can be copied and then changed under a different name using the “recipe editor expert” option, leaving the standard recipe untouched. Make notes of the changes, as the newly created recipes cannot be restored separately.
- ▶ With the function **delete recipe**, only recipes created with the recipe builder can be removed from the machine.
- ▶ The machine is unable to provide feedback (error) when the mixer motor is not running or when the canister motor is set to a very low speed.

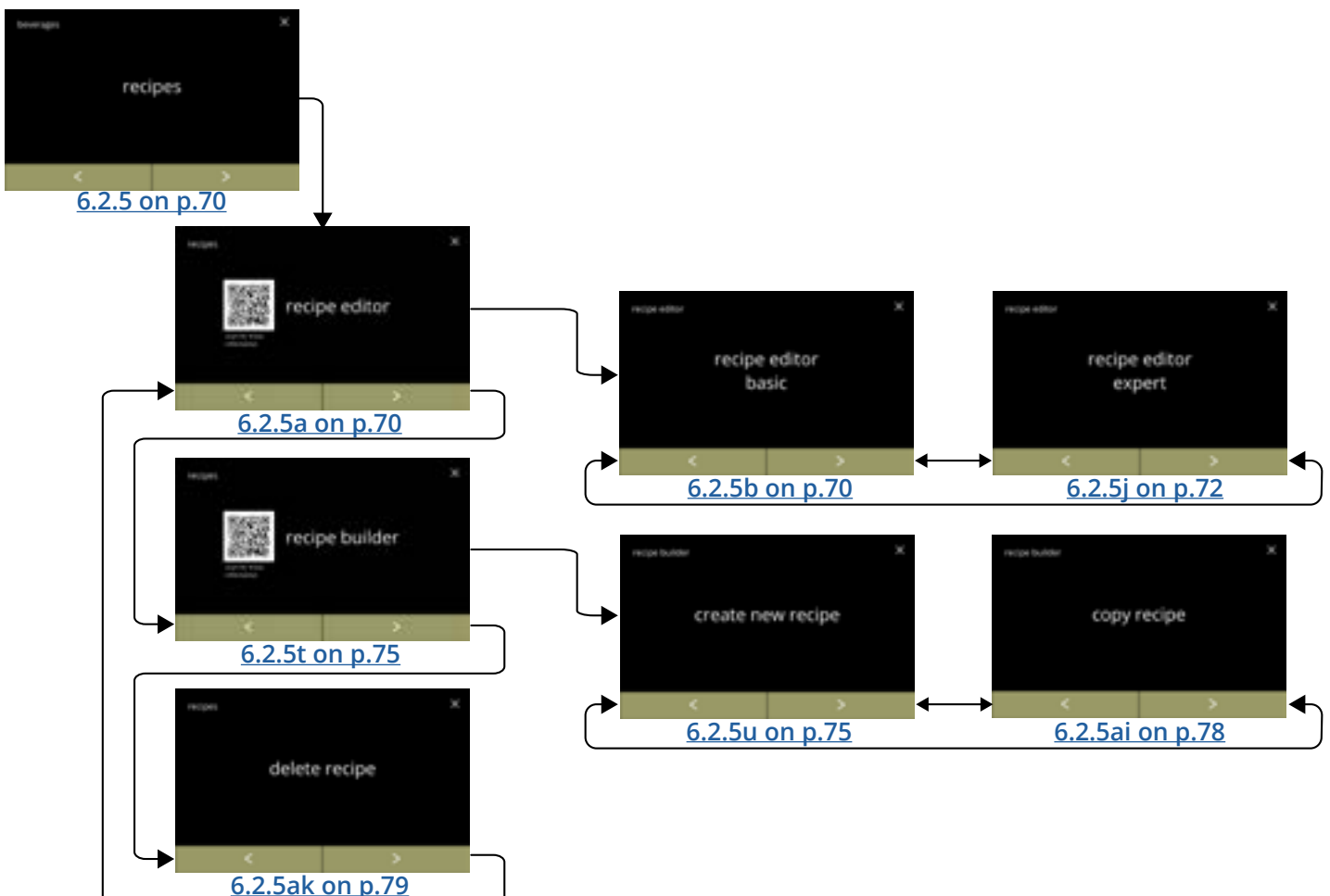



6.2.5

Change the recipe of a beverage:

- press "recipe" to confirm
- press ◀ or ▶ to scroll through the beverage menu



6.2.5a

Recipe carousel:

- press "recipe editor" to confirm
 - press ◀ or ▶ to scroll through the recipe sub-menu:
 - » recipe builder [6.2.5t on p.7573](#)
 - » delete recipe [6.2.5ak on p.7977](#)
- The QR-code in the screen refers to this manual



6.2.5b

Recipe editor carousel:

- press "recipe editor basic" to confirm
- press ◀ or ▶ to go to "recipe editor expert" ([6.2.5j on p.7270](#))



6.2.5c

Select the subdivision:

- press "decanter recipe" or "cup recipe" and go to the next screen



6.2.5d

Recipe selection:

- press or to select a beverage
- press to confirm



6.2.5e

Volume:

- press or to change the volume for the different cup sizes
- press to confirm and go to the next screen
- ▶ *Most volumes can be set from 0-30ml to 2000 ml (recipe dependent)*



6.2.5f

Strength:

- ▶ *Use the to switch between ratio and gram/120ml*
- press or to change the ratio ingredient/ water
- press to confirm
- ▶ *The number of ingredients may vary per beverage.*

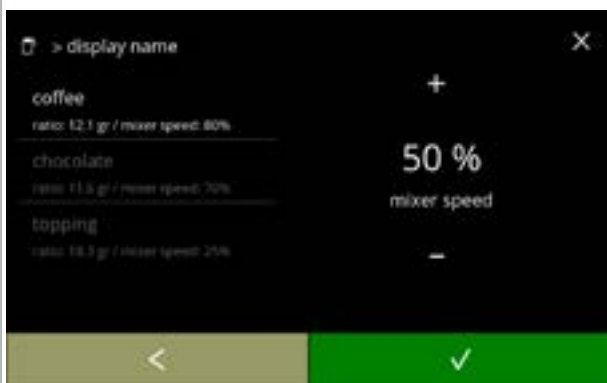

6.2.5g

Mixer speed:

- press or to change mixer speed
- press to confirm
 - » go to the previous screen for the next ingredient
 - » go to the following screen when all ingredients have been defined



Confirmation screen:

► On the left the summary of the new ingredient settings.

- press to confirm and to change the next ingredient (if available) and go to screen [6.2.5f](#)
- press **save** to confirm the last ingredient of the recipe is set and go to the next screen

6.2.5h



Information screen:

- screen [6.2.5aq](#) is displayed after a few seconds to test the recipe

6.2.5i



Recipe editor carousel:

- press "recipe editor expert" to confirm
- press or to go to "recipe editor basic" ([6.2.5b on p.70](#))

6.2.5j



Select the subdivision:

- press "decanter recipe" or "cup recipe" and go to the next screen

6.2.5k

6.2.5l



Recipe selection:

- press **↕** or **↕** to select a beverage
- press **➤** to confirm

6.2.5m



Volume:

- press **+** or **-** to change the volume for the different cup sizes
- press **➤** to confirm and go to the next screen
- ▶ *Most volumes can be set from 0-30ml to 2000 ml (recipe dependent)*

6.2.5n



Strength:

- ▶ *Use the **↕** to switch between ratio and gram/120ml*
- press **+** or **-** to change the ratio ingredient/water
- press **✓** to confirm
- ▶ *The number of ingredients may vary per beverage.*

6.2.5o

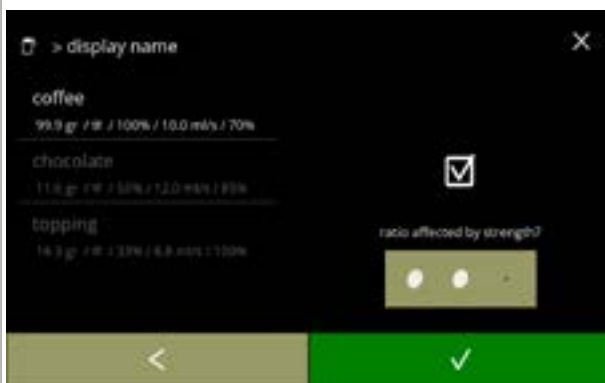

Ingredient affected by the strength-buttons:

- press on the checkbox
- ▶ *This determines whether or not an ingredient is modified when the strength setting on the beverage selection screen is changed, see [4.1a on p.7](#)*
- press **✓** to confirm
- ▶ *For ingredients that already have a high dosage, it is better not to use this option; large quantities of powder can cause a blockage in the mixing chamber.*

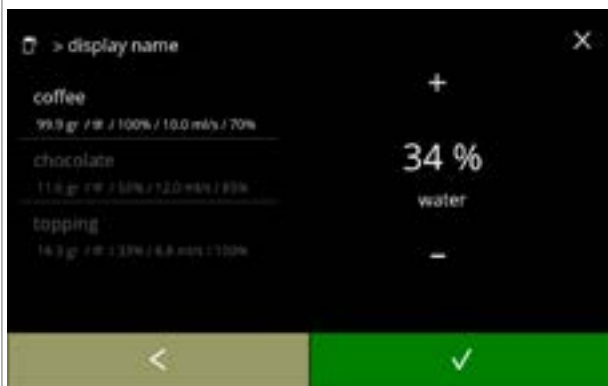

Water ratio ingredients:

- press **+** or **-** to change the percentage for the selected ingredient
- ▶ *All ingredients together must be distributed at 100%.*
- press **✓** to confirm

6.2.5p

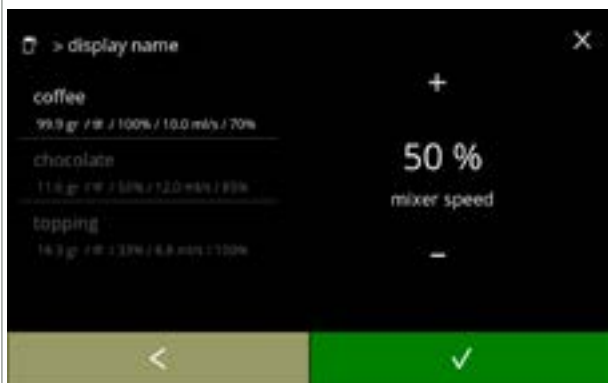

Mixer speed:

- press **+** or **-** to change mixer speed for the selected ingredient
- press **✓** to confirm
 - » go to the previous screen for the next ingredient
 - » go to the following screen when all ingredients have been defined

6.2.5q



Confirmation screen:

- ▶ *On the left the summary of the new ingredient settings.*
- press **✓** to confirm and to change the next ingredient (if available) and go to screen [6.2.5n](#)
- press **save** to confirm the last ingredient of the recipe is set and go to the next screen

6.2.5r

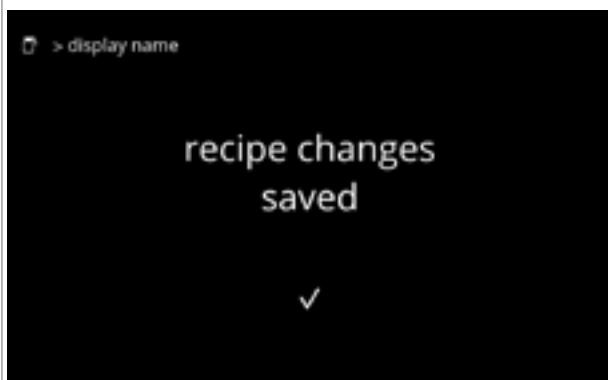

Information screen:

- screen [6.2.5aq](#) is displayed after a few seconds to test the recipe

6.2.5s



6.2.5t

Recipe carousel:

- press "recipe builder" to confirm
- press ◀ or ▶ to scroll through the recipe sub-menu:
 - » delete recipe [6.2.5ak on p.79](#)
 - » recipe editor [6.2.5a on p.70](#)
- ▶ *The QR-code in the screen refers to this manual (online).*



6.2.5u

Recipe builder carousel:

- press "create new recipe" to confirm
- press ◀ or ▶ to go to "copy recipe" ([6.2.5ai on p.78](#))



6.2.5v

Recipe name:

- ▶ *A recipe name must be unique, the beverage name can be changed later.*
- press ▶ or "enter recipe name" to confirm

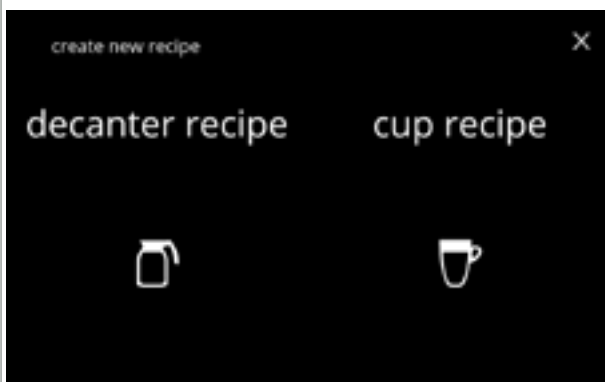

6.2.5w

Select the subdivision:

- press "decanter recipe" or "cup recipe" and go to the next screen



Enter the new unique recipe name:

- press **◀** or **▶** to scroll through the alphabet
- press the character between the **◀ ▶** to form the new beverage name
 - » press **ABC** for capitals
 - » press **à..ç..ê** for special characters
 - » press **123#*** for numbers
 - » press for a space
 - » press **✕** to remove a previous input
- press **✓** to confirm the new recipe name

6.2.5x



Choose a beverage icon (optional):

- press **▲** or **▼** to scroll through the standard beverage icons
- press the icon to select
- press **✓** to confirm
 - ▶ *Confirm is only active if something has changed.*
 - ▶ *At a later stage, customer-specific beverage images can be chosen ([§6.2.3 on p.65](#))*

6.2.5y



Choose an ingredient:

- press **▲** or **▼** to scroll through the ingredients
- press the ingredient name to select
- press **✓** to confirm
 - ▶ *No new ingredients can be added*
 - ▶ *If an ingredient does not exist, a "premix" can be used and renamed.*

6.2.5z



Choose another ingredient:

- press **[add ingredient]** to go to the previous screen
- press **▶** to enter the next screen
 - ▶ *No other ingredients can be chosen in a copied recipe, so **[add ingredient]** is not selectable.*

6.2.5aa



Volume:

- press **+** or **-** to change the volume for the different cup sizes
- press **▶** to confirm and go to the next screen
- ▶ *Most volumes can be set from 0-30ml to 2000 ml (recipe dependent)*

6.2.5ab



Strength:

- ▶ *Use the **↕** to switch between ratio and gram/120ml*
- press **+** or **-** to change the ratio ingredient/ water
- press **✔** to confirm
- ▶ *The number of ingredients may vary per beverage.*

6.2.5ac



Ingredient affected by the strength-buttons:

- press on the checkbox
- ▶ *This determines whether or not an ingredient is modified when the strength setting on the beverage selection screen is changed, see [4.1a on p.7](#)*
- press **✔** to confirm
- ▶ *For ingredients that already have a high dosage, it is better not to use this option; large quantities of powder can cause a blockage in the mixing chamber.*

6.2.5ad



Ratio between ingredients:

- press **+** or **-** to change the percentage for the selected ingredient
- ▶ *All ingredients together must be distributed at 100%.*
- press **✔** to confirm

6.2.5ae

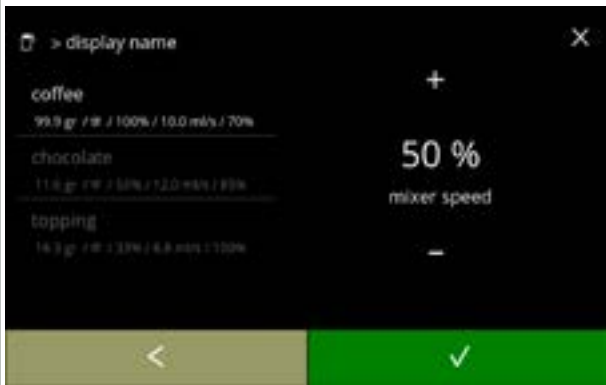

6.2.5af

Mixer speed:

- press **+** or **-** to change mixer speed for the selected ingredient
- press **✓** to confirm
 - » go to the previous screen for the next ingredient
 - » go to the following screen when all ingredients have been defined



6.2.5ag

Confirmation screen:

- *On the left the summary of the new ingredient settings.*
- press **✓** to confirm and to change the next ingredient (if available) and go to screen [6.2.5ac](#)
- press **save** to confirm the last ingredient of the recipe is set and go to the next screen



6.2.5ah

Information screen:

- screen ([6.2.5ag](#)) is displayed after a few seconds to test the recipe



6.2.5ai

Recipe builder carousel:

- *A new recipe is created on the basis of an already existing recipe. After the recipe has been copied, it must be given a unique name and further edited in the "recipe editor".*
- press "copy recipe" to confirm
- press **◀** or **▶** to go to "create new recipe" ([6.2.5u on p.75](#))

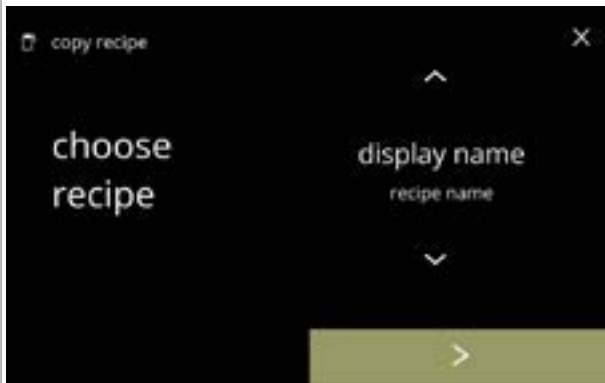

6.2.5aj

Copy recipe:

- press **▲** or **▼** to select a recipe
- press **▶** to confirm and go to [6.2.5u on p.75](#)



6.2.5ak

Recipe carousel:

- press "delete recipe" to confirm
- press **◀** or **▶** to scroll through the recipe sub-menu:
 - » recipe editor [6.2.5a on p.70](#)
 - » recipe builder [6.2.5t on p.75](#)
- ▶ *Only new created recipes can be deleted, default recipes will be reset to their default settings.*

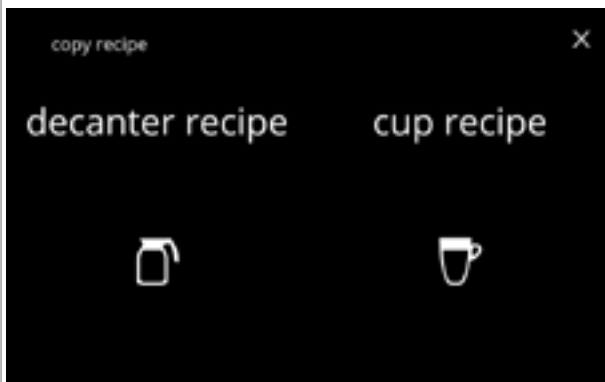

6.2.5al

Select the subdivision:

- press "decanter recipe" or "cup recipe" and go to the next screen

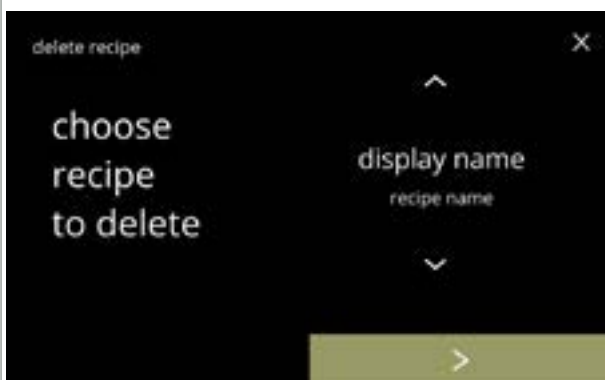

6.2.5am

Delete recipe:

- press **▲** or **▼** to select a recipe
- press **▶** to confirm
 - » for a new recipe go to the next screen
 - » for a default recipe go to screen [6.2.5ao](#)

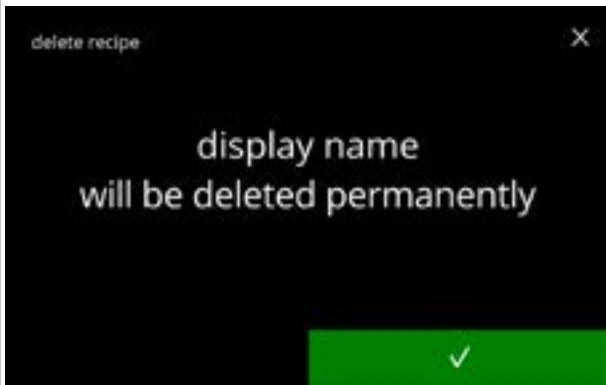

6.2.5an

Confirmation screen:

- press to confirm and go to screen [6.2.5ap](#)

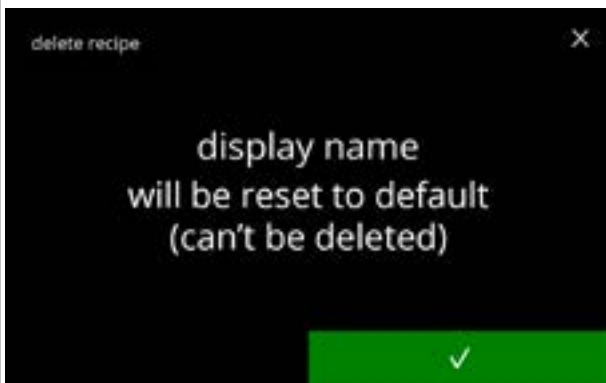

6.2.5ao

Confirmation screen:

- press to confirm and go to the next screen
 - ▶ *The beverage will also be removed from the beverage selection screen.*

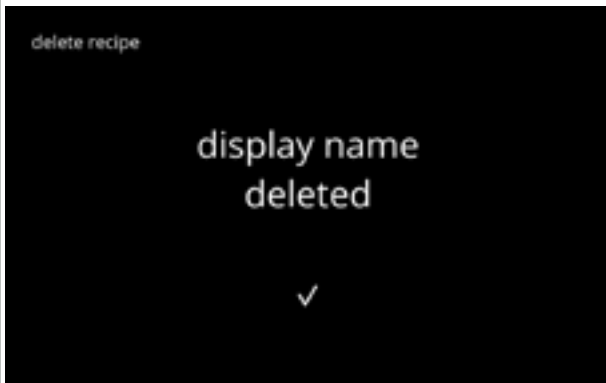

6.2.5ap

Information screen:

- screen [6.2.5am](#) is displayed after a few seconds



6.2.5aq

Test recipe:

- press **no**, depending on the starting point, one of the following screens will appear:
 - » recipe editor basic [6.2.5b on p.70](#)
 - » recipe editor expert [6.2.5j on p.72](#)
 - » create new recipe [6.2.5j on p.72](#)
 - » copy recipe [6.2.5j on p.72](#)
- press **yes** to go to the next screen

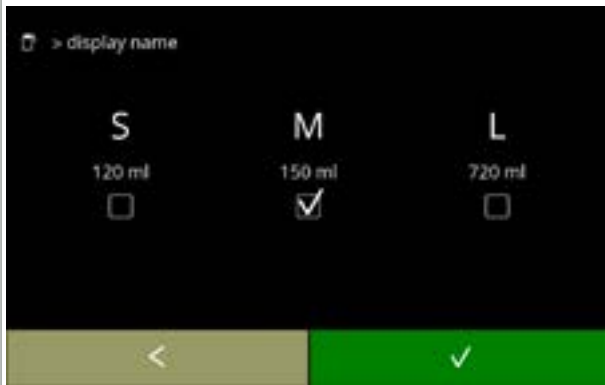

Test volume:

- press one of the volumes
- press **✓** to confirm
- press **←** to go to the previous screen

6.2.5ar



Information screen:

- place an empty container under the beverage outlet
- press **start** to begin the dosing

6.2.5as



Preparing a beverage:

- please wait

6.2.5at



Testing:

- check the volume and the strength/taste
- recipe **not ok**, press **no**, depending on your starting point, one of the following screens will appear:
 - » standard recipe, go to the next screen
 - » new/copied recipe, go to screen [6.2.5m on p.73](#)
- recipe **ok**, press **yes**, screen [6.2.5ax](#) is displayed

6.2.5au

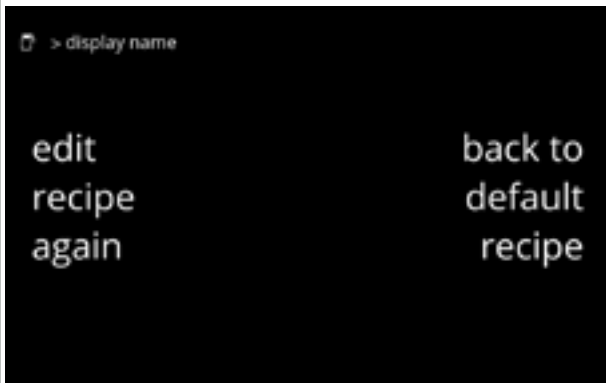

6.2.5av

Recipe not satisfactory:

- press **back to default recipe** to undo the modifications and go to the next screen
- press **edit recipe again**, depending on your starting point, one of the following screens will appear:
 - » recipe editor basic [6.2.5e on p.71](#)
 - » recipe editor expert [6.2.5m on p.73](#)



6.2.5aw

Back to default recipe:

- please wait, depending on your starting point, one of the following screens will appear after a few seconds:
 - » recipe editor basic [6.2.5b on p.70](#)
 - » recipe editor expert [6.2.5j on p.72](#)



6.2.5ax

Test another volume:

- press **yes** go to [6.2.5ar](#)
- press **no**, depending on your starting point, one of the following screens will appear:
 - » recipe editor basic [6.2.5b on p.70](#)
 - » recipe editor expert [6.2.5j on p.72](#)
 - » create new recipe [6.2.5u on p.75](#)
 - » copy recipe [6.2.5ai on p.78](#)

6.2.6 Select ingredients canisters

Default *instant* ingredients will be available in the machine:

- | | | | |
|-------------------|-----------|---------|---------------------|
| • regular coffee | • topping | • sugar | • custom ingredient |
| • espresso coffee | • cacao | • soup | • Premix 1 - 6 |

- ▶ Only use ingredients that are suitable for vending machines.
- ▶ Names of ingredients can be changed in [§6.2.7 on p.86](#).
- ▶ If an ingredient is changed or removed, any beverage containing that ingredient will be removed from the screen.
- ▶ For unknown ingredients premix 1 to 6 are available. Rename the premixes in [§6.2.7 on p.86](#).



6.2.6

Select an ingredient per canister:

- press "select ingredient canister" to confirm
- press **◀** or **▶** to scroll through the beverage menu

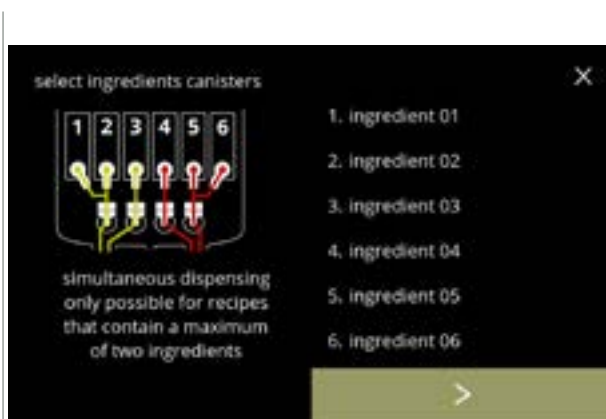

6.2.6a

Select an ingredient:

- press **▶** to select the next canister ([6.2.6e](#))
- ▶ The screen depends on the configuration of the machine, see [§8.3 on p.139](#).
- press on an ingredient to select and go to the next screen
- ▶ Confirm **✔** is only active if something has changed.



6.2.6b

Assign an ingredient to a canister:

- press **▲** or **▼** to scroll through the available ingredients
 - » select an existing ingredient and press **✔** go to [6.2.6e](#)
 - » select 'custom ingredient' (to type an unique ingredient name), press **✔** and go to the next screen
- ▶ 'No ingredient' is also possible
- ▶ The number of steps to be completed depends on the number of canisters.

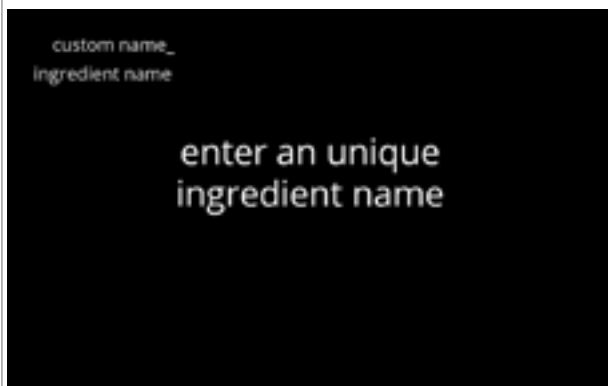

6.2.6c

Information screen:

- screen [6.2.6d](#) is displayed after a few seconds



6.2.6d

Enter the new custom ingredient name:

- press **◀** or **▶** to scroll through the alphabet
- press the character between the **◀ ▶** to form the new ingredient name
 - » press **ABC** for capitals
 - » press **à..ç..ê** for special characters
 - » press **123#*** for numbers
 - » press for a space
 - » press **✕** to remove a previous input
- press **✓** to confirm the new ingredient name

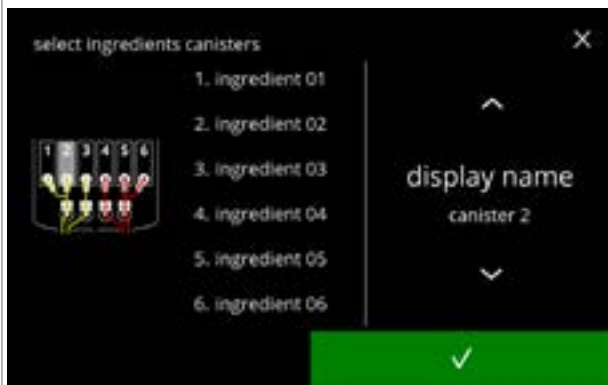

6.2.6e

Next canister(s):

- ▶ *The screen depends on the configuration of the machine, see [§8.3 on p.139](#).*
- press **▲** or **▼** to scroll through the available ingredients
- press on an ingredient to select and go to the next screen press **✓** and go to the next screen
- ▶ *Confirm **✓** is only active if something has changed.*

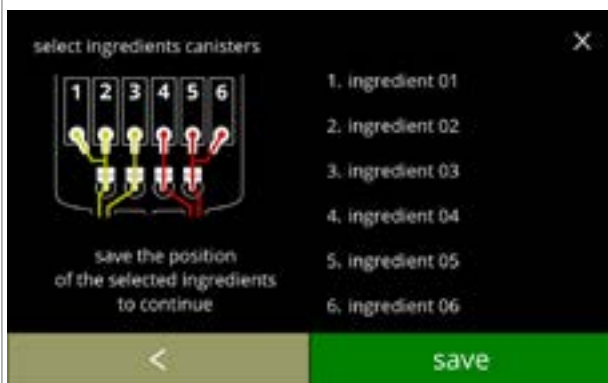

6.2.6f

Control screen:

- ▶ *This screen appears when **✓** or **▶** is pressed after the last canister.*
- press **◀** to select the previous screen
- press **save** to confirm



6.2.6g

Information screen:

- screen [6.2.6](#) is displayed after a few seconds

► *Only if a new ingredient is different to the original one go to [§6.2.1 on p.61](#). The beverages made with the previous ingredient are set to inactive and their names have been replaced by the 3 dots. That is why you have to combine new beverages with the buttons. When this action is completed, the machine will be operational again with the new ingredients.*

6.2.7 Change ingredient name

In this menu the name of the ingredient can be changed to a custom defined ingredient name.

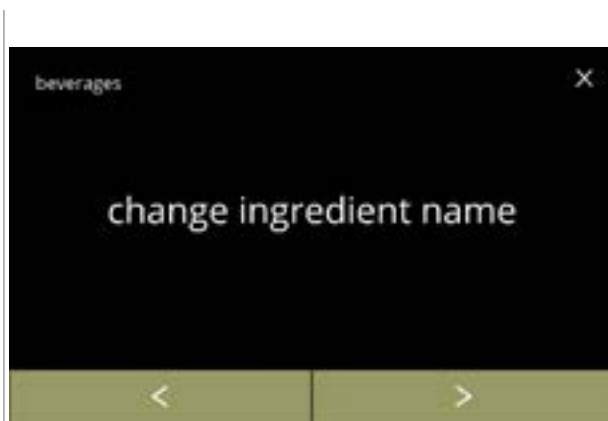

6.2.7

Change ingredient name:

- press "change ingredient name" to confirm
- press **◀** or **▶** to scroll through the beverage menu



6.2.7a

Available ingredient canisters:

- press **◀** or **▶** to scroll through the available ingredient canisters
- press on an ingredient to select and go to the next screen



6.2.7b

Enter the new custom ingredient name:

- press **◀** or **▶** to scroll through the alphabet
- press the character between the **◀ ▶** to form the new ingredient name
 - » press **ABC** for capitals
 - » press **à..ç..ê** for special characters
 - » press **123#*** for numbers
 - » press for a space
 - » press **X** to remove a previous input
- press **✓** to confirm the new ingredient name

Information screens:

- screen [6.2.7a](#) is displayed after a few seconds

6.2.7c

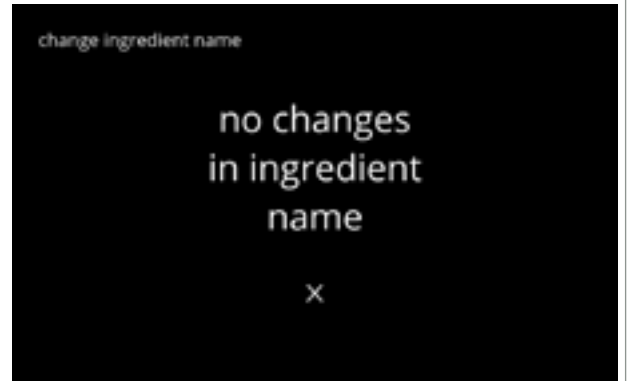
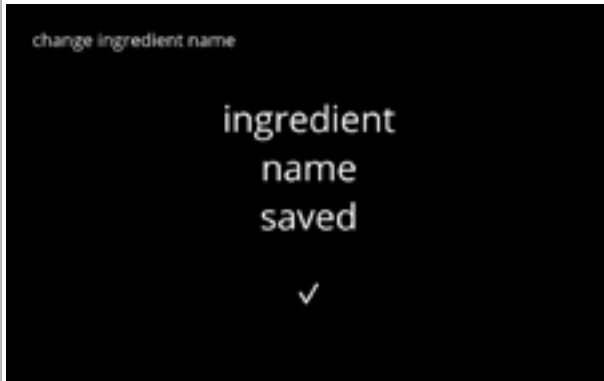

6.2.8 Customize beverage strength

In this menu, the standard strength on the beverage selection screen can be set. The step size (%) of the strength can also be adjusted (0-20%). This default setting applies to all beverages in the beverage selection screen.

step size (6.2.8a)			standard strength setting (6.2.8c)
1%	minimum		90%
10%	standaard		100%
20%	maximum		110%

► Setting the step size to 0% turns off the strength control and the button disappears from the beverage selection screen.



6.2.8

Set the beverage strength increase (%):

- press "customize beverage strength" to confirm
- press or to scroll through the beverage menu



6.2.8a

Set the step size (%) of the beverage strength:

- press or to set the step size (%) of the strength button and go to the next screen
- press or to go to screen 6.2.8c to set the default strength

► Setting the step size to 0% turns off the strength control and the button disappears from the beverage selection screen.

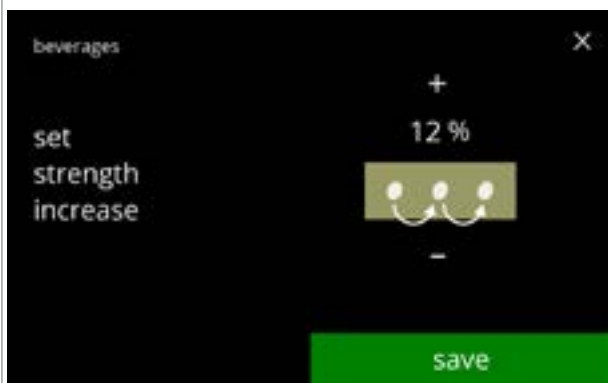

6.2.8b

Confirm changes:

- press to confirm

► Save is only active if something has changed.



6.2.8c

Change the default strength:

- press **▲** or **▼** to set the default strength
- press **◀** or **▶** to scroll through the beverage strength menu



6.2.8d

Confirm changes:

- press **save** to confirm
- ▶ *Save is only active if something has changed.*



No selectable strength button:

- ▶ *Setting the step size to 0% (screen [6.2.8a](#)) turns off the strength control and the button disappears from the beverage selection screen.*





6.2.9 Set default volume

In this menu, the standard volume of the beverage selection screen can be set. This default setting applies to all beverages in the beverage selection screen. The amount of ml per beverage can be adjusted in the recipe menu [§6.2.5 on p.69](#).



6.2.9

Change the default volume:

- press  or  to set the default volume
- press  or  to scroll through the beverage menu



6.2.9a

Confirm changes:

- press  to confirm
- ▶ *Save is only active if something has changed.*

6.2.10 Simultaneously dispensable beverages

This *information menu* can be used to check which beverages can be dispensed simultaneously.

The beverages that can be dispensed on both sides at the same time depend on the ingredients that are linked to the mixing systems that are connected to the respective side of the beverage outlets.

The water selector, which supplies the water to the different mixing systems, also has a certain influence on the beverages that can be dispensed at the same time.

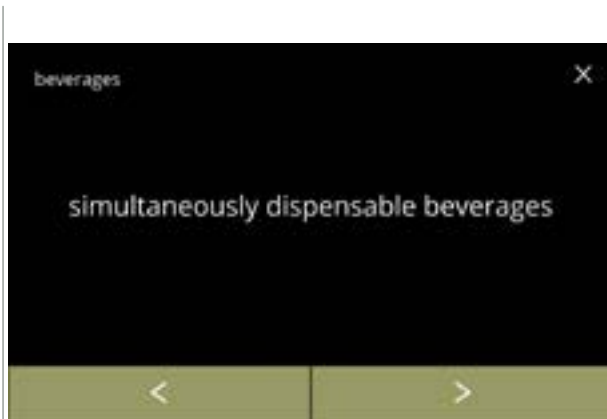

Check simultaneous dispensed beverages

- press "Simultaneously dispensable beverages" to confirm
- press ◀ or ▶ to scroll through the beverage menu

6.2.10

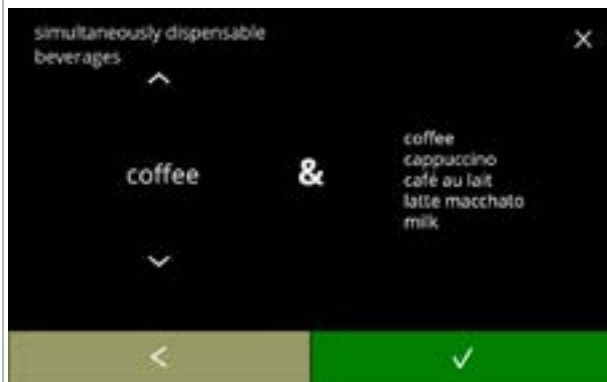

Information screen:

- press ◀ or ▶ to select a beverage
- press ✓ to confirm

► On the right side of the screen a list of all beverages that can be dispensed at the same time as the selected beverage on the left.

6.2.10a

6.3 Machine menu

You can programme the machine settings in the this menu.

Select one of the available options:

- press **◀** or **▶** to select the next option of the “machine menu”
- press the “text area” to select the next level for that menu
- press **⌫** to go back to [chapter 6. Programming menu on p.17](#)

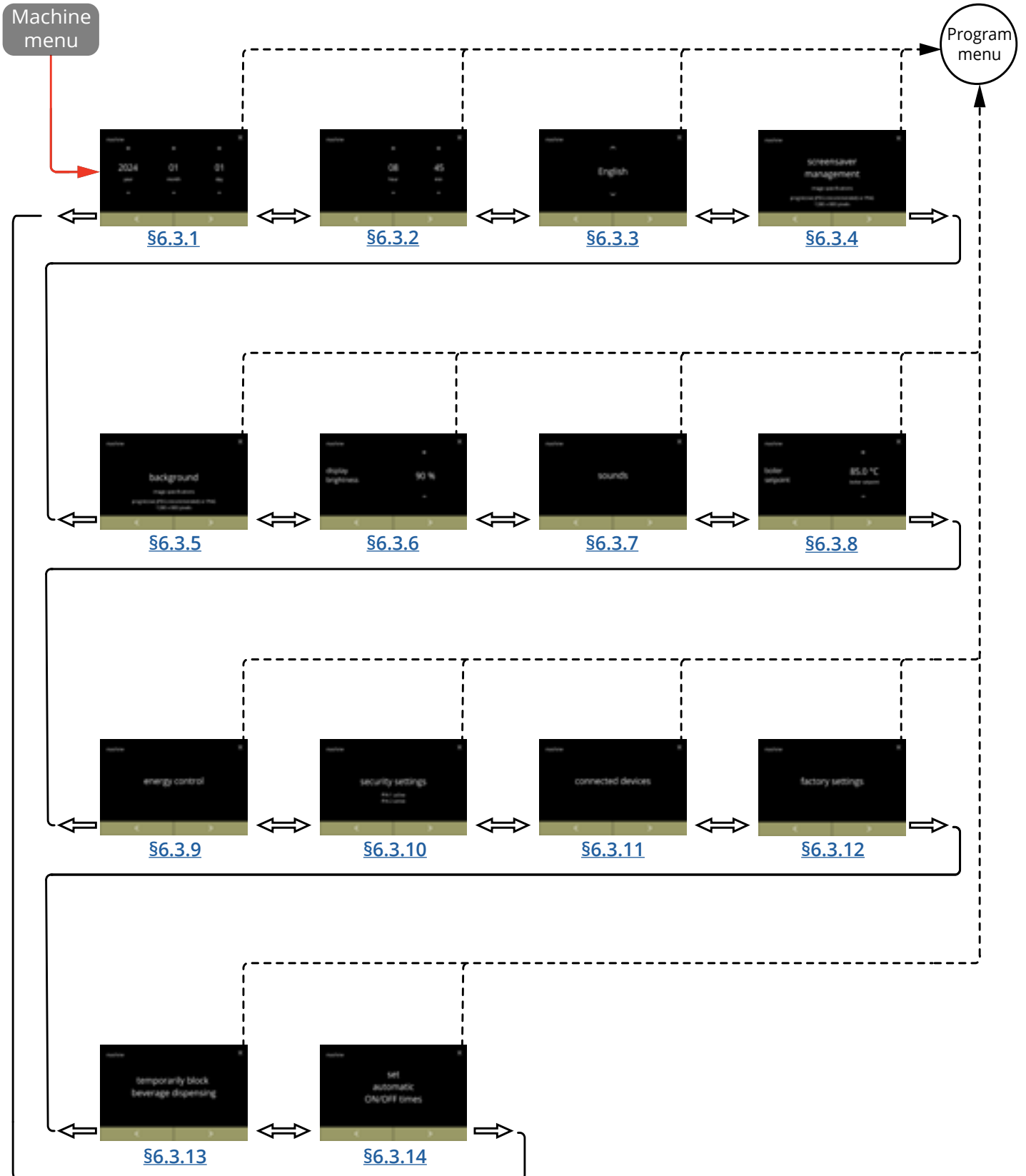

6.3.1 Date

Adjust the year/month/date.

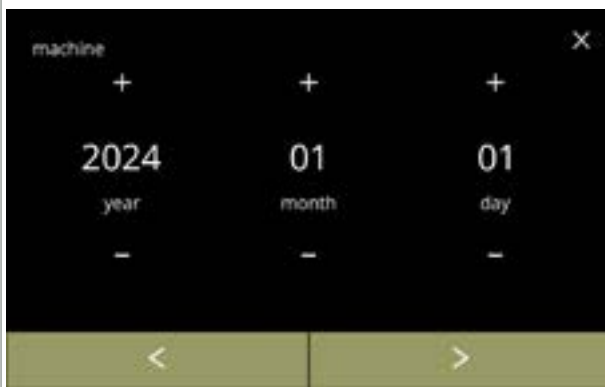

6.3.1

Change the date:

- press **+** or **-** to set the year, month or day
- press **←** or **→** to scroll through the machine menu

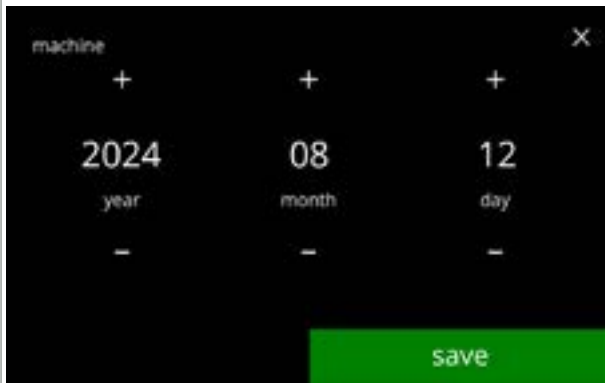

6.3.1a

Confirm changes:

- press **save** to confirm
- ▶ *Save is only active if something has changed.*

6.3.2 Time

Adjust the time.

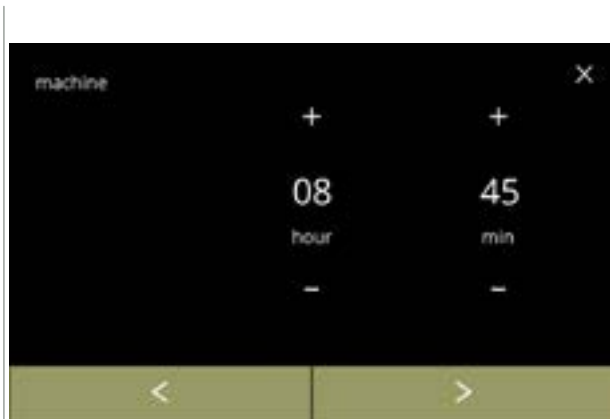

6.3.2

Change the time:

- press **+** or **-** to set the current hour and minutes
- press **<** or **>** to scroll through the machine menu

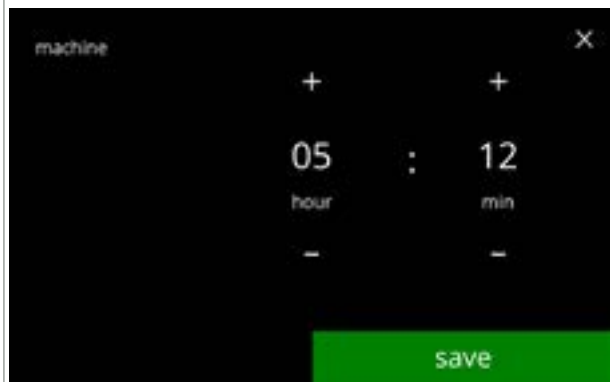

6.3.2a

Confirm changes:

- press **save** to confirm
- ▶ *Save is only active if something has changed.*

6.3.3 Language

The available languages are:



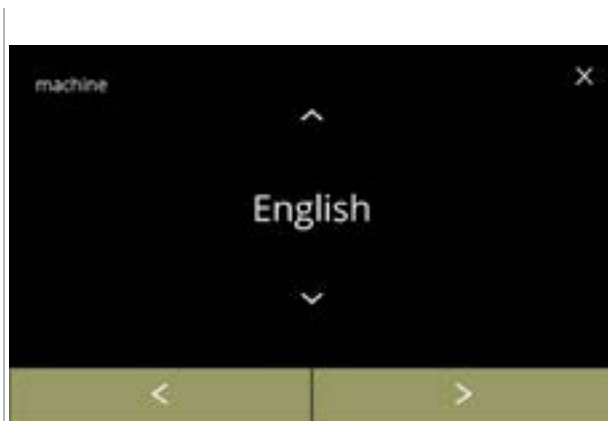

- English
- Spanish
- French
- Italian
- Dutch
- Norwegian
- Polish
- Portuguese
- Swedish
- Danish
- German

Default: English



6.3.3

Change the language:

- press  or  to scroll through the available languages
- press the language to set as the current language
- press  or  to scroll through the machine menu

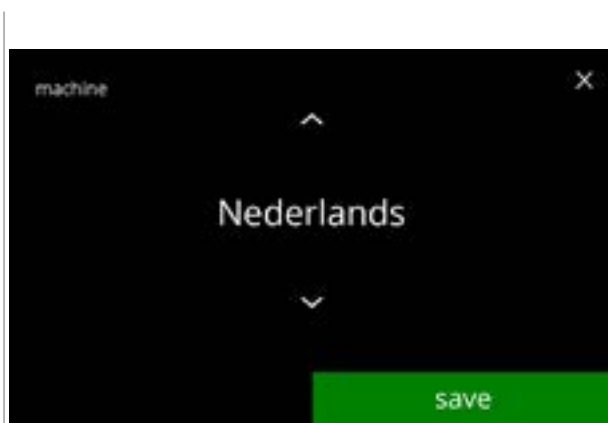

6.3.3a

Confirm change:

- press  to confirm
- ▶ *Save is only active if something has changed.*

6.3.4 Screensaver management

In this menu, you can set when the screen saver becomes active.

setting	screensaver
default	15 min.
minimum	1 min.
maximum	90 min.

The screensaver can be set to a custom defined screensaver. You can always return to the default screensaver.

- ▶ The screensaver image does not need for a transparent background.
- ▶ The screensaver can also be disabled (see screen [6.3.4a](#))



6.3.4

Change the screensaver:

- press "screensaver management" to confirm
- press **◀** or **▶** to scroll through the machine menu

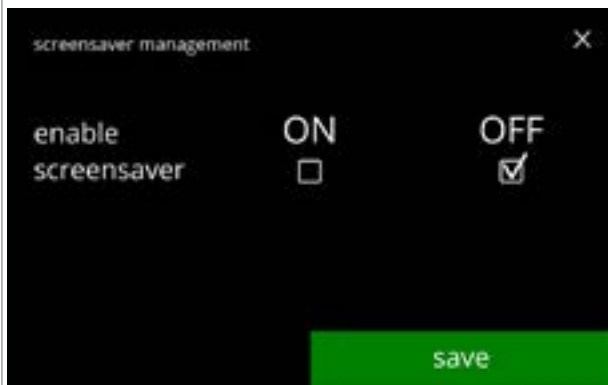

6.3.4a

Activate/deactivate the screensaver option:

- press the checkbox to set the screensaver:
 - » select OFF and **save**: go to the next screen
 - » select ON and **✓**: go to screen [6.3.4c](#)
- ▶ Save is only active if something has changed.

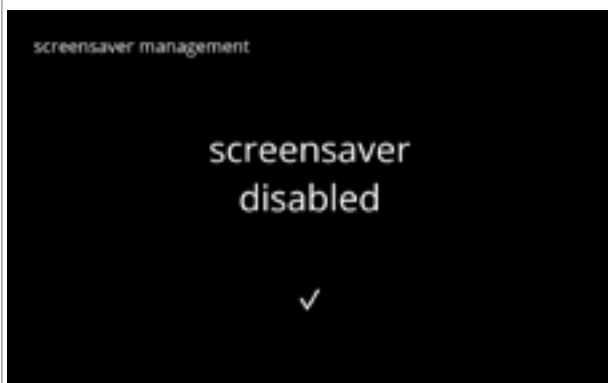

6.3.4b

Information screen:

- screen [6.3.4](#) is displayed after a few seconds

6.3.4c

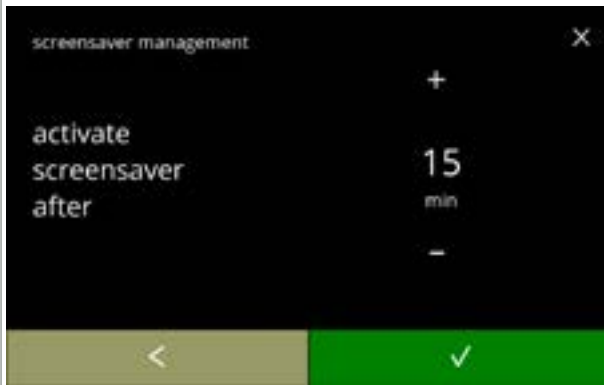

Set the time when the screensaver becomes active

- press **+** or **-** to select the activation time
- press **✓** to confirm

6.3.4d



Change the screensaver image:

- press **▶** to go to the next screen
- place a USB stick
 - ▶ *If there is no USB stick in the machine this option is greyed out.*
- press **+** or **-** to select a custom image, see specifications below
- press **save** to go to the next screen
 - ▶ *The image  means it can take a while.*

6.3.4e

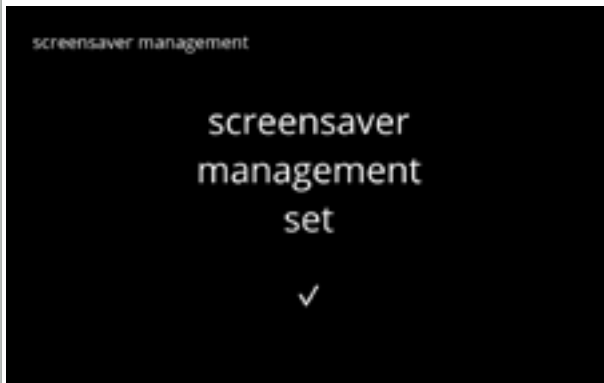

Information screens:

- screen [6.3.4](#) is displayed after a few seconds

6.3.5 Background

In this menu the background of the beverage selection screen can be set. The background can be set to a custom defined background, see specifications. The default background remains available in the GUI, so you can always return to the default background.

► We recommend **not** to use a light colour or white because of the readability.

6.3.5



Change the background:

- press "background" to confirm
- press ◀ or ▶ to scroll through the machine menu

6.3.5a

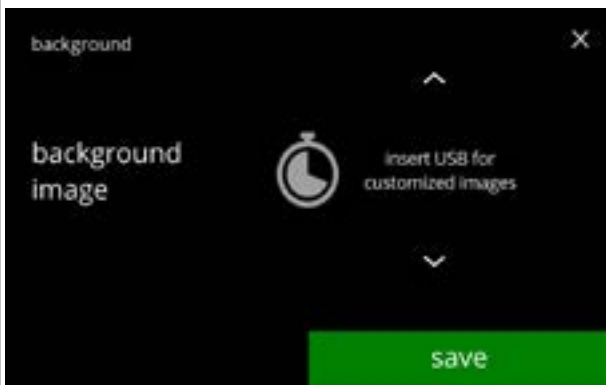

Change the background image:

- press ▶ to go to the next screen
- place a USB stick
 - If there is no USB stick in the machine this option is greyed out.
- press ⏪ or ⏩ to select a custom image
- press **save** to go to the next screen
 - Save is only active if something has changed.
 - The image ⌚ means it can take a while.

6.3.5b

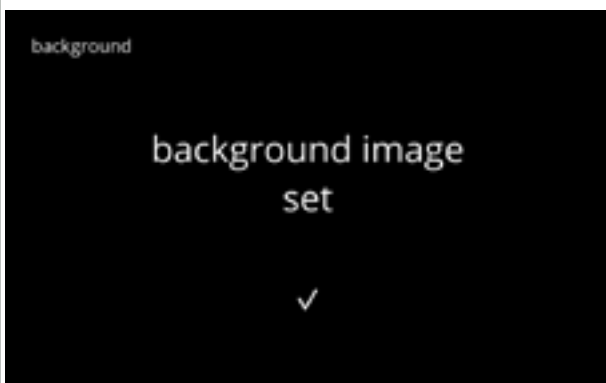

Information screen:

- screen [6.3.5](#) is displayed after a few seconds

6.3.6 Display brightness

The brightness of the display can be increased or decreased in steps of 5%.

setting	brightness
default	60%
minimum	20%
maximum	100%

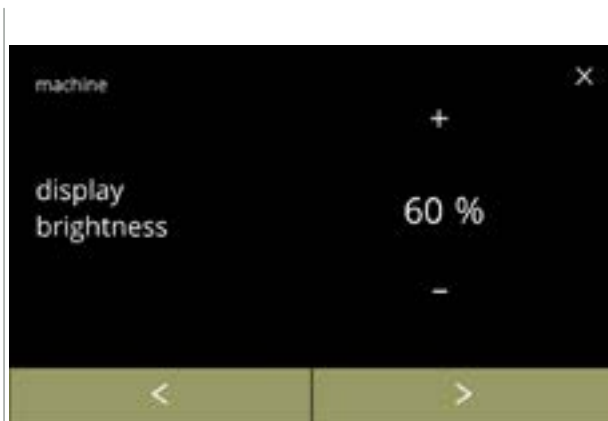

6.3.6

Change the display brightness:

- press **+** or **-** to select the brightness
- press **←** or **→** to scroll through the machine menu

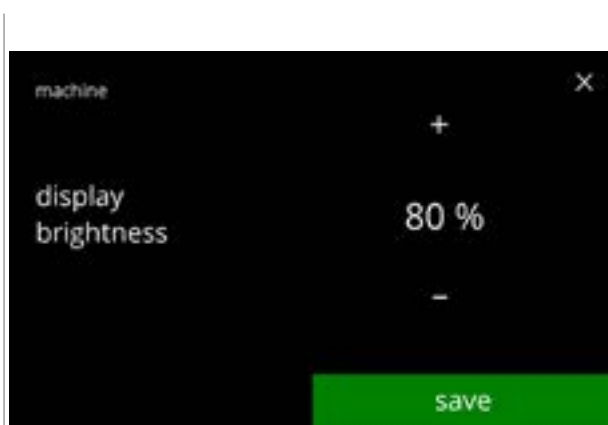

6.3.6a

Confirm change:

- press **save** to confirm
- ▶ *Save is only active if something has changed.*

6.3.7 Sound level feedback

The sound level of the feedback can be increased or decreased.

setting	sound level
default	50%
minimum	0% (OFF)
maximum	100%

An end of dose sound can be enabled (disabled by default).
This indicates that the dose is complete

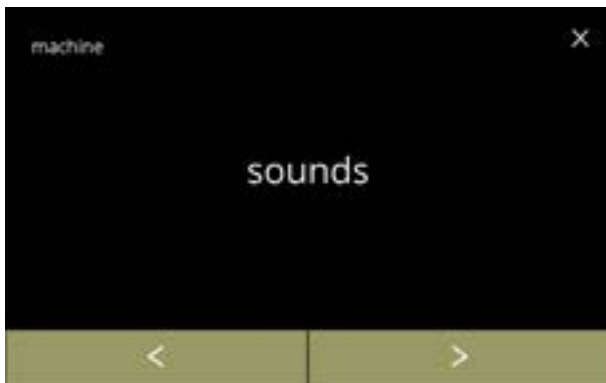

6.3.7

Change the sound feedback:

- press "sounds" to confirm
- press **◀** or **▶** to scroll through the machine menu

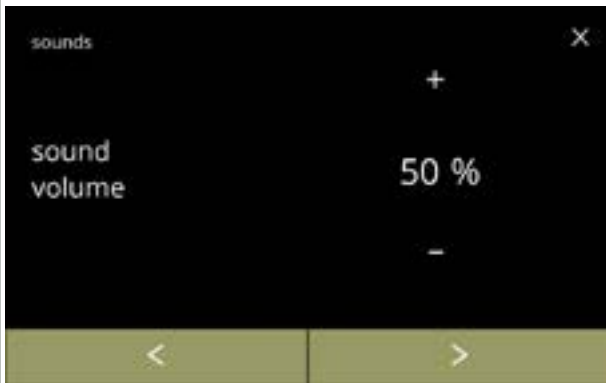

6.3.7a

Sound level feedback:

- press **+** or **-** to set the sound level
 - ▶ *When the audio volume is increased or decreased, a beep is generated in that volume for verification.*
- press **◀** or **▶** to go to screen [6.3.7c](#)

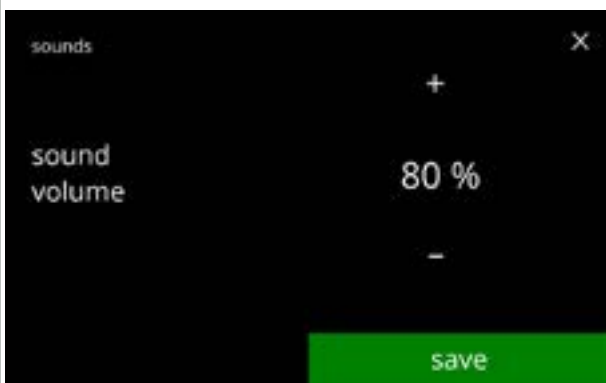

6.3.7b

Confirm change:

- press **save** to confirm and go to screen [6.3.7](#)
 - ▶ *Save is only active if something has changed.*



6.3.7c

Activating/deactivating the beverage end signal:

- press the checkbox to set the signal
- press **←** or **→** to go to screen [6.3.7a](#)

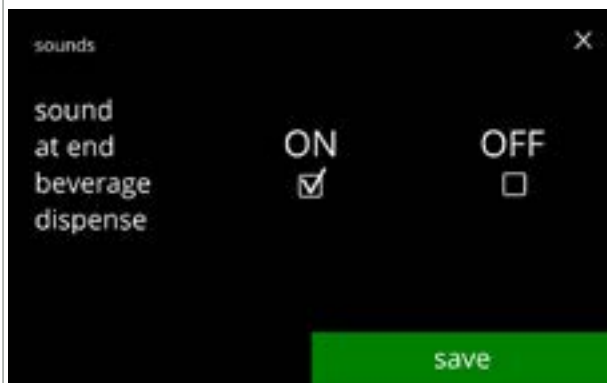

6.3.7d

Confirm change:

- press **save** to confirm and go to screen [6.3.7](#)
 - ▶ *Save is only active if something has changed.*

6.3.8 Boiler temperature

The temperature is set with an absolute temperature setting in degrees Celsius

setting	temperature
default	85°C
minimum	80°C
maximum	90°C



6.3.8

Change the boiler temperature:

- press **+** or **-** to set the temperature
- press **←** or **→** to scroll through the machine menu

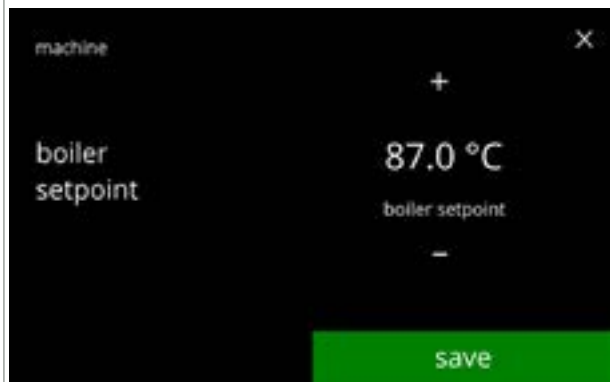

6.3.8a

Confirm change:

- press **save** to confirm
- ▶ *Save is only active if something has changed.*

6.3.9 Energy-saving mode (ECO)

After the set time, the Bolero will automatically go into sleep mode. The system becomes active when the screen is touched.

The time of the energy-saving mode can be set as defined in the table below.

1	2	3	4	5	6
Off	15 min.	30 min.	1 hour	2 hours	4 hours

Default: 2 hours

When energy-saving mode becomes active, the following actions are performed:

- boiler heating disabled
- backlight display set to low percentage.
- fan disabled

► *Energy control mode is dominant over screensaver mode*

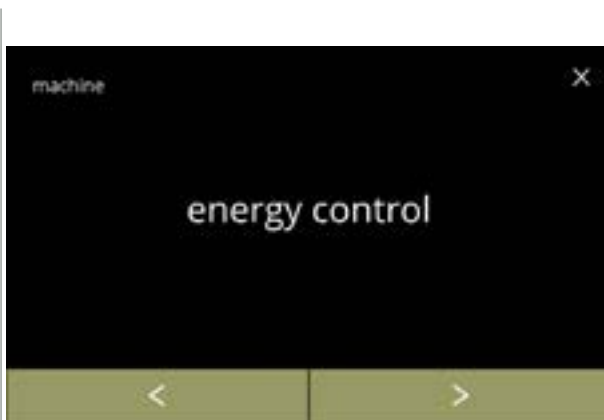

6.3.9

Change the energy-saving mode:

- press "eco modus" to confirm
- press ◀ or ▶ to scroll through the machine menu

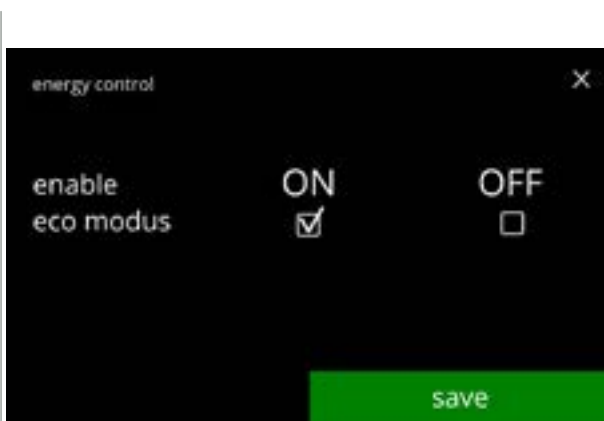

6.3.9a

Activate/deactivate the energy-saving mode option:

- press the checkbox to set energy-saving mode
 - » select OFF and **save**: go to the next screen
 - » select ON and **✓**: go to screen [6.3.9c](#)
- *Save is only active if something has changed.*

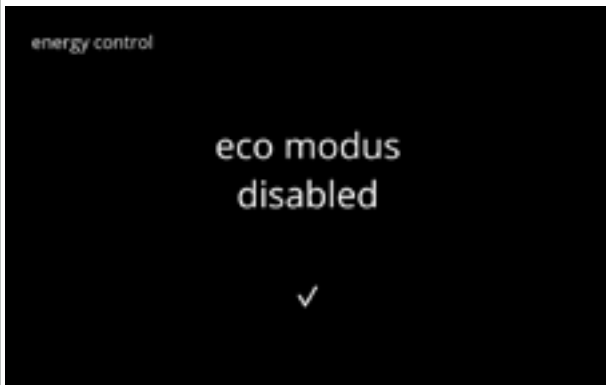

6.3.9b

Information screen:

- screen [6.3.9](#) is displayed after a few seconds



6.3.9c

Set the time when the eco modus becomes active:

- press **+** or **-** to select the activation time
- press the checkbox to set the boiler temperature at 70° C in eco-modus
- press **save** to confirm
- press **←** to go back to screen [6.3.9a](#)



6.3.9d

Information screen:

- screen [6.3.9](#) is displayed after a few seconds

6.3.10 Security settings

In this menu the PIN code settings can be defined.

There are 2 PIN codes:

- PIN 1 (general safeguard)
- PIN 2 (specific safeguard)



[§8.4 on p.146](#) describes which PIN codes protect which options.

If a PIN code is entered to access the menu, it remains valid until the user leaves the menu again.



6.3.10

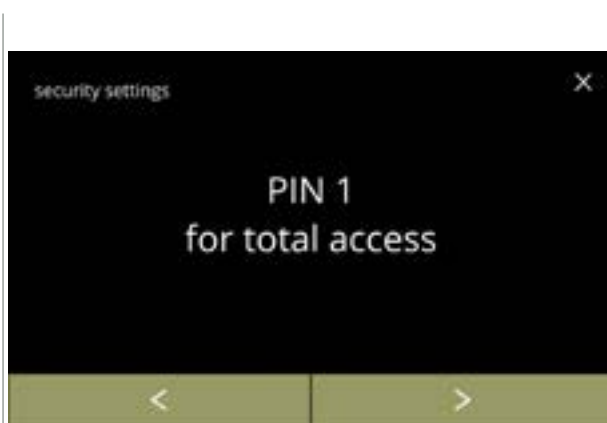

Change the security settings:

- press "security settings" to confirm
- press  or  to scroll through the machine menu
- ▶ If a PIN code is active, it is indicated on this screen.



6.3.10a

Change the security settings:

- press "PIN 1 for total access":
 - » PIN 1 already set: go to screen [6.3.10f](#)
 - » PIN 1 not yet set: go to the next screen
- press  or  to go to screen [6.3.10q](#) for PIN 2



6.3.10b

Set PIN code:

- press "Set PIN" and go to the next screen

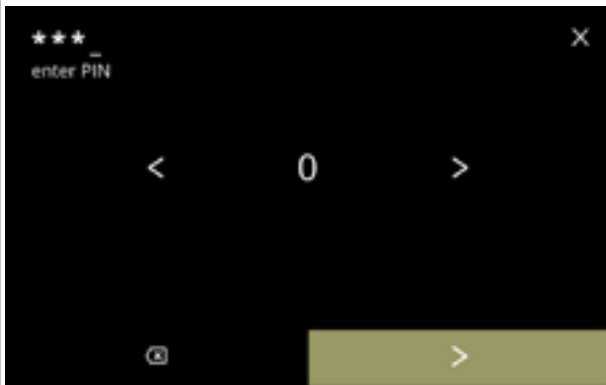

6.3.10c

Enter the PIN code:

- press **◀** or **▶** to scroll through the numbers
- press on the number to select
- press **ⓧ** to delete a PIN number, see left corner
- press **▶** when the 4 digit PIN code is entered
 - ▶ *When four numbers are entered the next screen is displayed to verify the PIN code.*



6.3.10d

Verify the PIN code:

- press **◀** or **▶** to scroll through the numbers
- press on the number to select
- press **ⓧ** to delete a PIN number, see left corner
- press **✓** to verify the PIN code entered and go to the next screen
 - ▶ *When the PIN code does **not** match, you will receive another attempt to enter the correct code.*



6.3.10e

Information screen:

- screen [6.3.10a](#) is displayed after a few seconds



6.3.10f

Change PIN 1:

- press "change PIN 1" to confirm and go to the next screen
- press **◀** or **▶** to go to screen [6.3.10m](#)

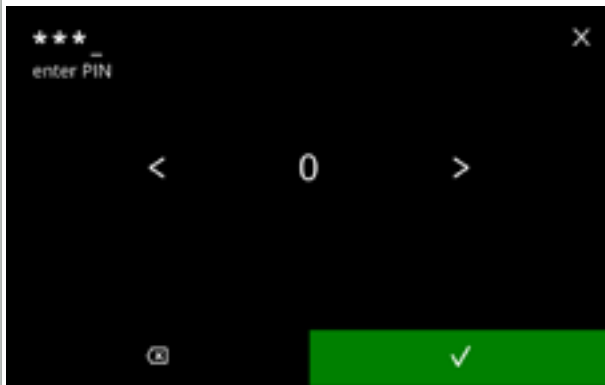

6.3.10g

Enter the PIN code:

- press or to scroll through the numbers
- press on the number to select
- press to delete a PIN number, see left corner
- press to verify the PIN code entered and go to the next screen

► *When the PIN code does **not** match, you will receive another attempt to enter the correct code.*

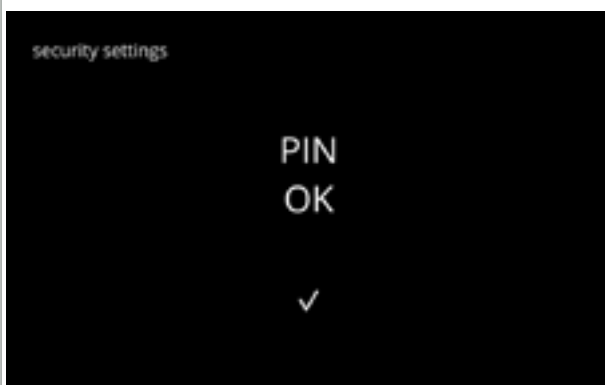

6.3.10h

Information screen:

- the next screen is displayed after a few seconds

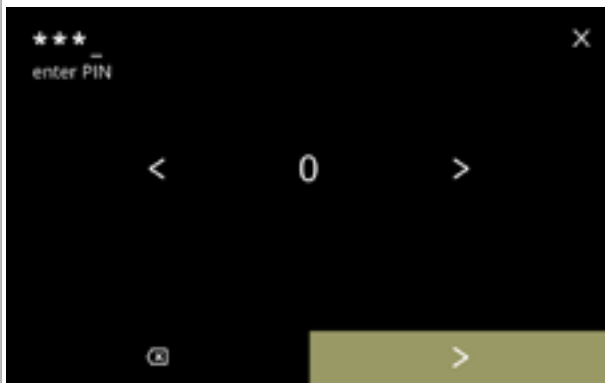

6.3.10i

Enter the new PIN code:

- press or to scroll through the numbers
- press on the number to select
- press to delete a PIN number, see left corner
- press when the 4 digit PIN code is entered

► *When four numbers are entered the next screen is displayed to verify the PIN code.*

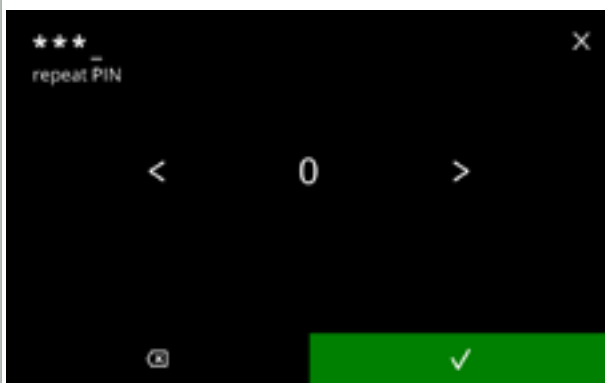

6.3.10j

Verify the new PIN code:

- press or to scroll through the numbers
- press on the number to select
- press to delete a PIN number, see left corner
- press to verify the PIN code entered and go to the next screen

► *When the PIN code does **not** match, you will receive another attempt to enter the correct code.*



6.3.10k

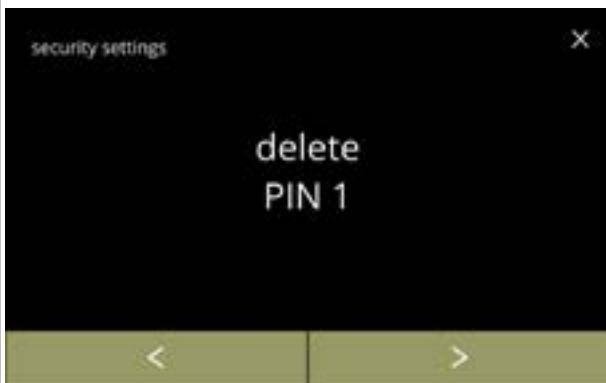

Information screen:

- screen [6.3.10a](#) is displayed after a few seconds



6.3.10l



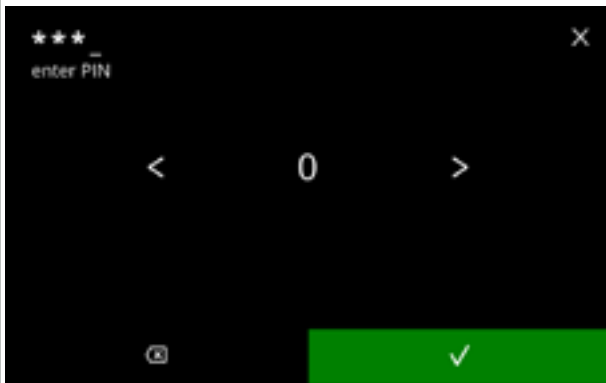

Delete PIN 1:

- press "delete PIN 1" to confirm and go to the next screen
- press  or  to go to screen [6.3.10f](#)



6.3.10m

Enter the PIN code:

- press  or  to scroll through the numbers
 - press on the number to select
 - press  to delete a PIN number, see left corner
 - press  to verify the PIN code entered and go to the next screen
- When the PIN code does **not** match, you will receive another attempt to enter the correct code.

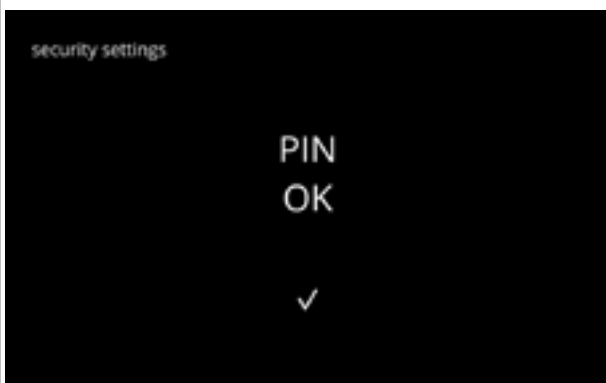

6.3.10n

Information screen:

- the next screen is displayed after a few seconds

Confirmation screen:

- press **✕** to cancel
- press **✓** to confirm and go to the next screen

6.3.10o

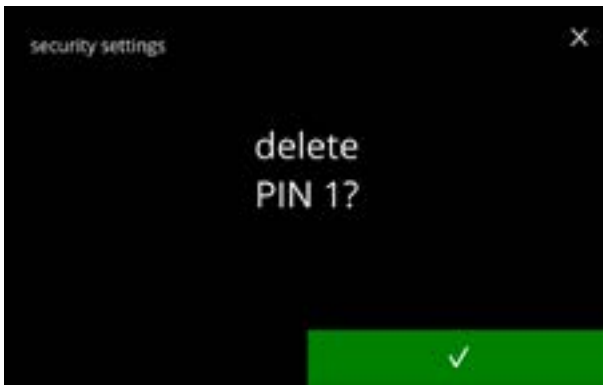

Information screen:

- screen [6.3.10a](#) is displayed after seconds

6.3.10p

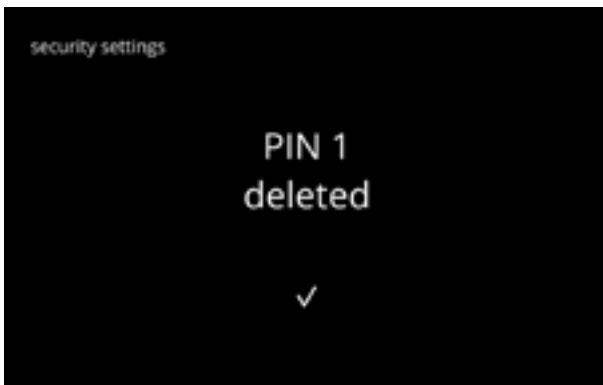

Change the security settings:

- press "PIN 2 for limited access" to select:
 - ▶ *The screens that follow are the same as PIN 1 (only PIN 1 is replaced by PIN 2 in the screens [6.3.10b](#) to [6.3.10p](#)).*
- press **◀** or **▶** to go to screen [6.3.10a](#) for PIN 1

6.3.10q



6.3.11 Connected devices

In this menu settings of external devices connected to the machine can be set or modified. In case of a connected payment module, the possibility to cancel a beverage can be disabled.

Devices that can be connected:

- payment devices (with and without coins)

▶ *A payment system requires an external power supply, ask your retailer about the options.*

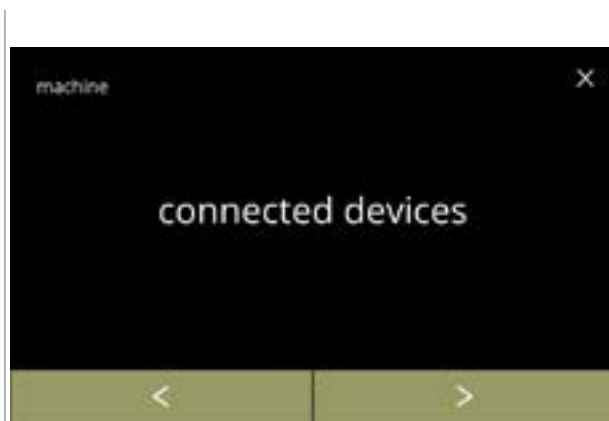

Select or configure the connected devices:

- press "connected devices" to confirm
- press **◀** or **▶** to scroll through the machine menu

▶ *If no external device is connected to the machine, the text on this screen will remain greyed out.*

6.3.11

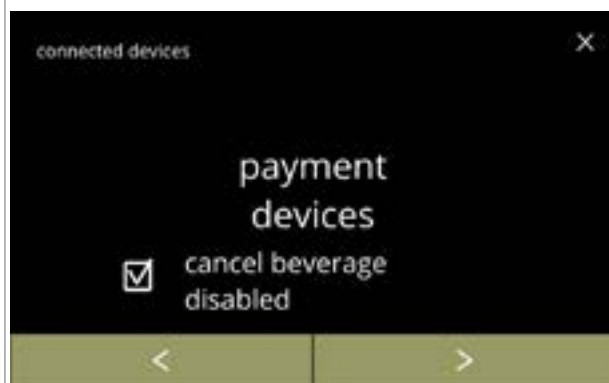

Payment device:

▶ *The checkbox gives the possibility to decide whether a paid beverage could be cancelled or not (the money is not returned).*

- press **▶** to confirm

6.3.11a

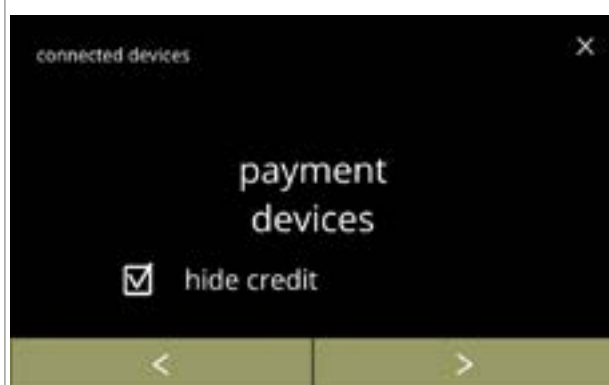

Payment device:

▶ *The checkbox gives the possibility to decide whether to hide the credits or not.*

- press **▶** to confirm

▶ *The "hide credit" option is particularly useful for payment devices that allocate a certain credit amount to ensure there is enough credit to pay for the beverage (such as a self-service petrol station).*

6.3.11b



Select/configure the payment device:

- press "select coins" to confirm
- press **◀** or **▶** to scroll for more connected payment devices

- ▶ *The availability of the navigation buttons depends on the number of connected devices.*
- ▶ *Up to 2 payment devices can be connected.*

6.3.11c

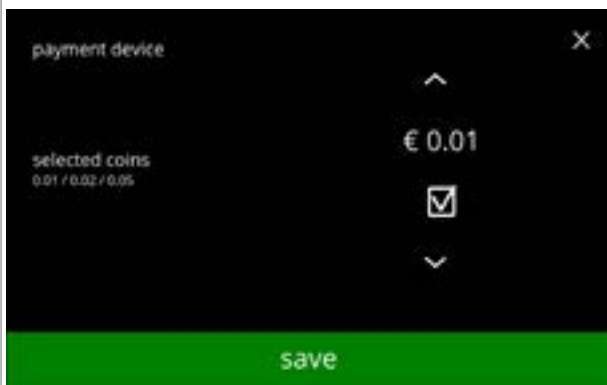

Select which coins can be used:

- press **▲** or **▼** to scroll through the available coins
- press the checkbox to set the coin
- press **save** to confirm and go to the next screen

- ▶ *Save is only active if something has changed.*

6.3.11d

Information screens:

- screen [6.3.11](#) is displayed after a few seconds

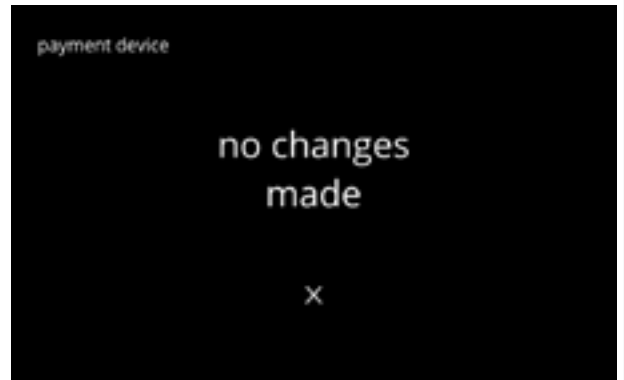
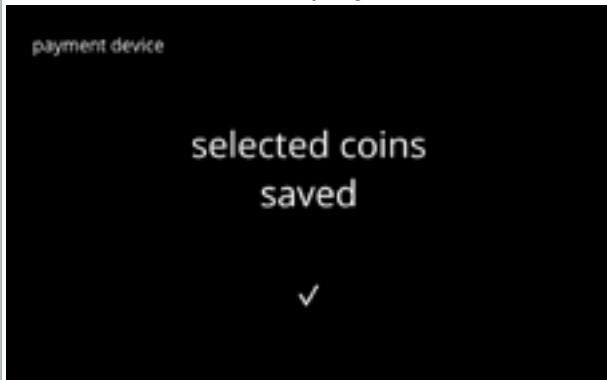

6.3.11e

6.3.12 Reset to factory settings



A factory reset returns the machine to its original state.

Exceptions are:

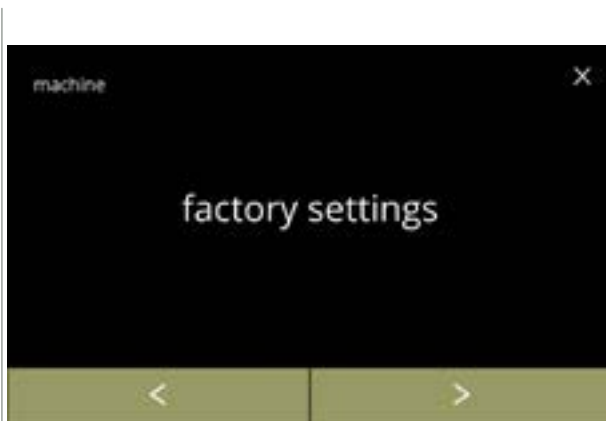
- firmware
- machine counter (only the day and beverage counters are reset)
- descale counter
- water filter
- firmware history



Reset to factory settings:

- press "factory settings" to confirm
- press  or  to scroll through the machine menu

6.3.12

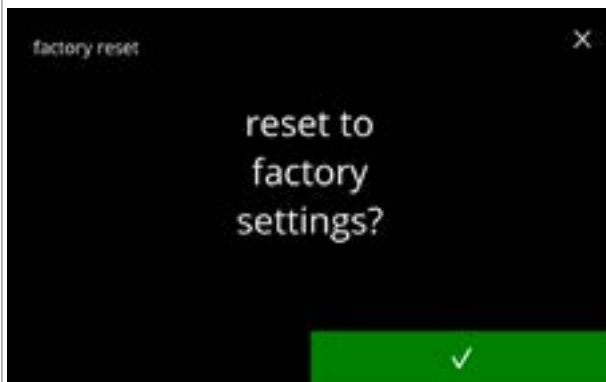

Confirmation screen:

- ▶ First save the customized data, see [§6.4.5 on p.124.](#)
- press  to confirm

6.3.12a

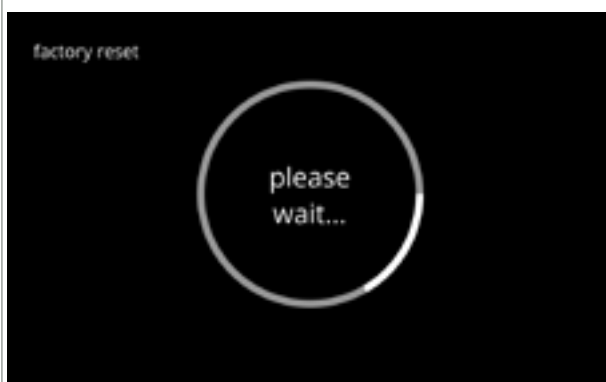

Progress screen

- wait until the process is finished

6.3.12b



Information screen:

- the next screen is displayed after a few seconds

6.3.12c



Information screen:

- the machine starts automatically (this takes a while)

6.3.12d

6.3.13 Set blocking times

It is possible to block the dispensing of beverages for certain periods.

The option can be chosen to enable hot water dispensing during blocking times.

During those blocking times all the beverage icons on the beverage selection screen are inactive and grey out. If a greyed out button is pressed when a blocking time is active, the machine will display screen [6.3.13e](#) for 3 seconds.

In case hot water is available during the blocking times, the hot water icon is the only active icon. The checkbox 'enable hot water during blocking times' is only active once at least one blocking time is set.

Up to 4 blocking times can be set, each represented by a white button.



Set the blocking times:

- press "temporarily block beverage dispensing" to confirm
- press **◀** or **▶** to scroll through the machine menu

6.3.13

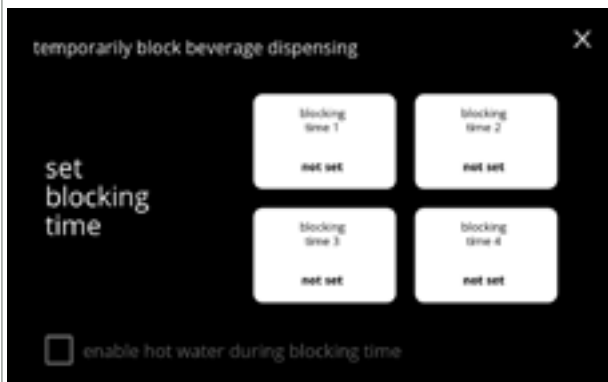

Selection screen:

- press the blocking time to select and go to the next screen

6.3.13a

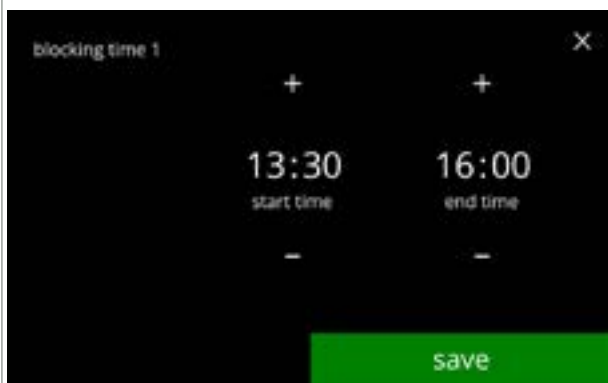

Change the time:

- press **+** or **-** to set the begin and end time with steps of 15 minutes (= setting)
- press **save** to confirm
- ▶ If a blocking time has been set, the white button will show a green outline, see screen [6.3.13d](#).
- ▶ If the start and end times are the same, the blocking time is **not** set.

6.3.13b

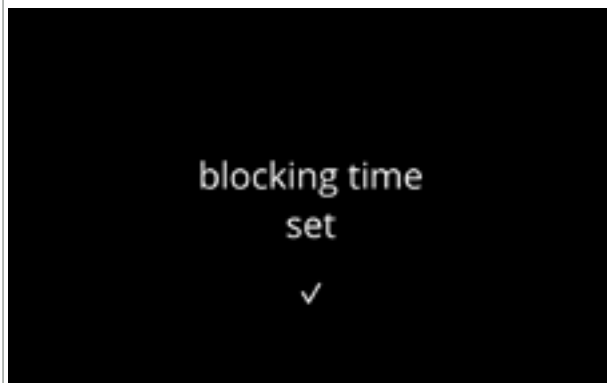

Information screen:

- the next screen is displayed after a few seconds

6.3.13c



Enable hot water:

- press the checkbox to enable hot water during blocking time
- press another blocking time to set
- press **X** and return to screen [6.3.13](#)

6.3.13d

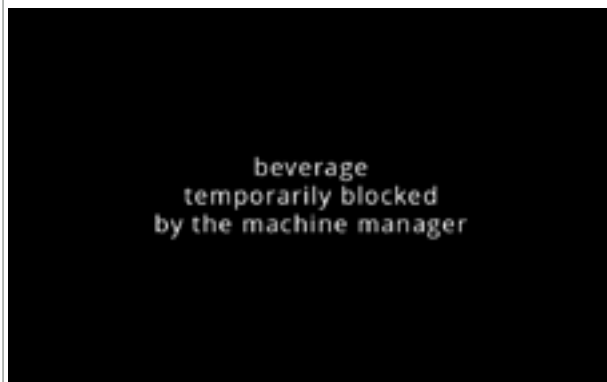

Information screen:

- If a greyed out button is pressed when a blocking time is active, the machine will display this screen for 3 seconds.

6.3.13e



6.3.14 Set automatic ON/OFF times

The main purpose of this function is to make sure the machine is *ready for use* at a defined time and *shuts down* at a defined time.

If the start time is set e.g. om 8.00 o'clock in the morning, this means the machine must be ready to dispense beverages from that time on. If the end time is set to e.g. 18.00 all the processes are switched off at that time. The display will show a sign-of-life, so the users can understand the machine is in some kind of 'hibernate-modus'. The sign-of-life is the strength icon, the stylized coffee bean , moving over the screen (in the same way as the tree icon moves in eco-modus). The display intensity is set to an as low as possible value, so the strength icon is just visible, see screen [6.3.14f](#).



Set the automatic ON/OFF times:

- press "set the automatic ON/OFF times" to confirm
- press  or  to scroll through the machine menu

6.3.14





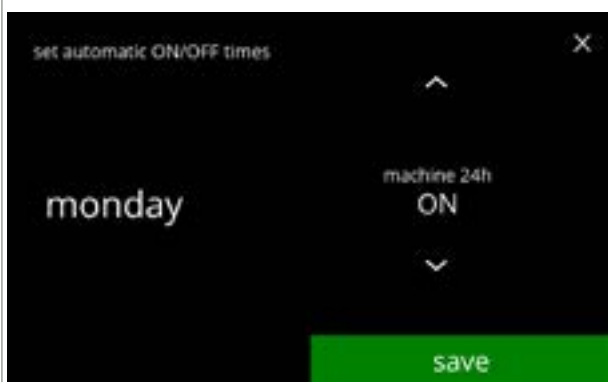

Selection screen:

- press a day to select and go to the next screen
- ▶ *If an automatic time is set (standard ON), the white button will show a green outline, see screen [6.3.13d](#).*

6.3.14a



Change the time:

- press  or  to select the possible options
 - » ON 24 hours
 - » OFF 24 hours
- press  to confirm and go to screen [6.3.14d](#) or
 - » set specific time
- press  to go to the next screen

6.3.14b

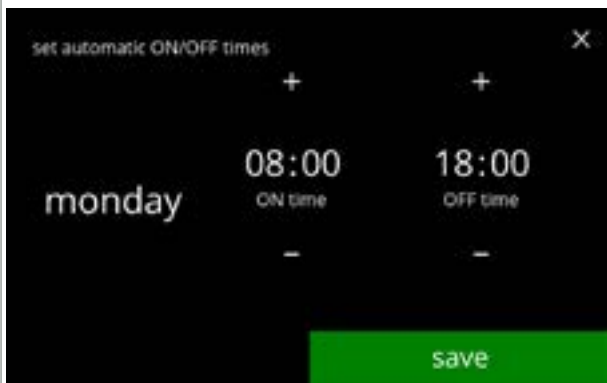

6.3.14c

Change the time:

- press **+** or **-** to set the ON and OFF time
- press **save** to confirm and go to the next screen

- ▶ *By default the ON-time is set to 08:00 and the OFF-time to 18:00.*
- ▶ *The ON and OFF time can never be the same.*



6.3.14d

Information screen:

- the next screen is displayed after a few seconds



6.3.14e

Selection screen:

- press another day time to set
- press **✕** and return to screen [6.3.14](#)

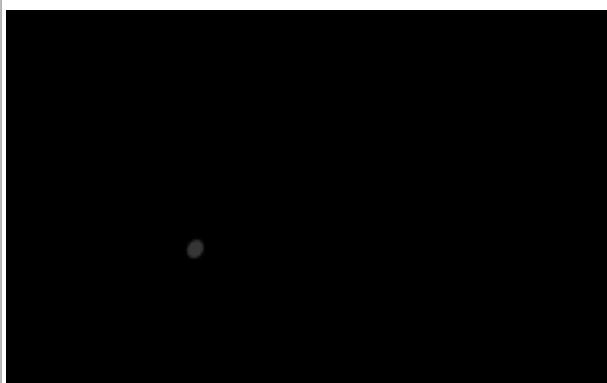

6.3.14f

Waking up a machine after the OFF status:

- touching the screen
 - ▶ *The machine 'wakes up' and the Beverage Selection Screen is shown. The boiler needs to be warmed before a beverage can be dispensed and this is communicated by the boiler heating screen see [3k on p.5](#).*
 - ▶ *If the machine has been woken up during OFF time, it returns to this OFF state 15 minutes after the last user action.*

6.4 Software menu

All firmware related items can be read, set or changed in the software menu.

Select one of the available options:

- press **◀** or **▶** to select the next option of the "software menu"
- press the "text area" to select the next level for that menu
- press **⏪** to go back to [chapter 6. Programming menu on p.17](#)

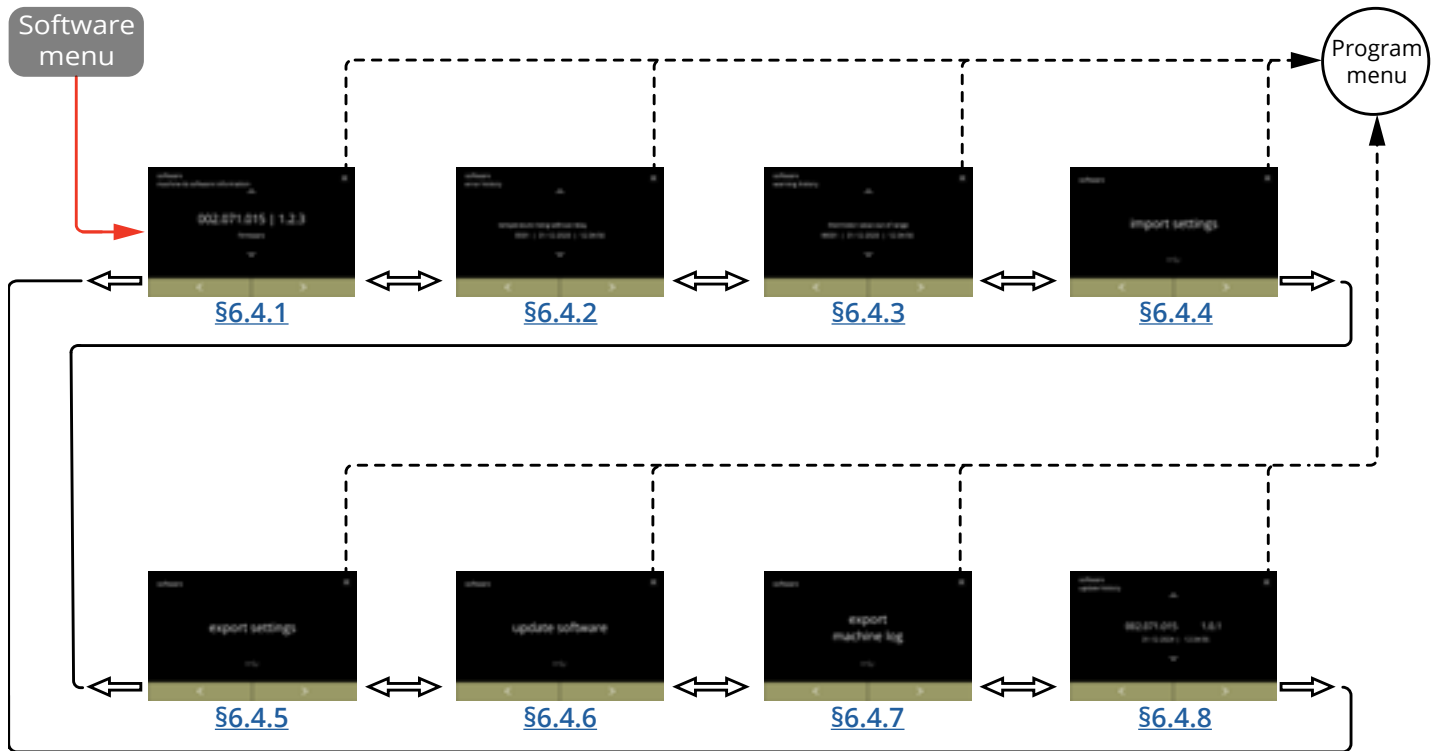

6.4.1 Machine and software information





This menu shows information that identifies the machine.

<i>software</i>			<i>hardware (version, article number)</i>	<i>other</i>
HMI (version)	I/O (version)	external (version, article number)		
• bootloader	• bootloader	• Interface board (if present)	• HMI board	• IP information (IP address, Mac address, Gateway and DNS) (if connected)
• application » API » GUI	• application	• other devices (if present)	• I/O board	
• touchscreen controller			• interface print (if present)	
• Bluetooth/Wi-Fi			• other devices (if present)	



6.4.1

Information screens:

- press  or  to retrieve the other machine & software information
- press  or  to scroll through the software menu

6.4.2 Error log

In this menu the error history is shown.

The following items are displayed:

- error code
- error message
- date and time

The error log can contain up to 50 error messages, the last error code generated is displayed first.

► An overview of the error messages can be found in [§7.2 on p.134](#).

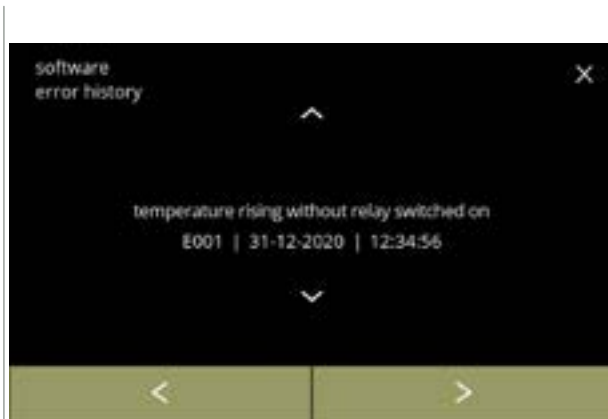

6.4.2

Information screens:

- press or to retrieve the error history
- press or to scroll through the software menu

► *The last error code generated is shown first.*

6.4.3 Warning log

In this menu the warning history is shown.

The following items are displayed:

- warning code
- warning message
- date and time

The warning log can contain up to 50 warning messages, the last warning code generated is displayed first.

► An overview of the warning messages can be found in [§7.1 on p.132](#).

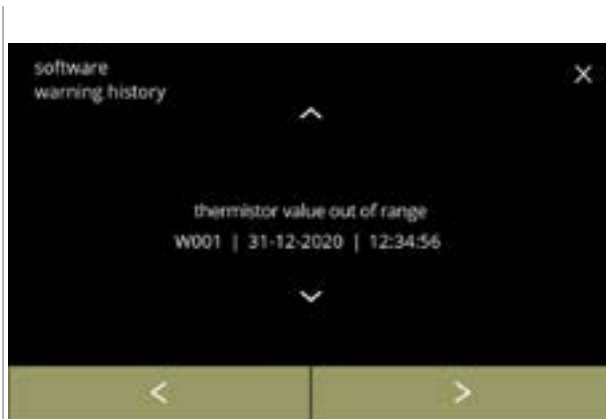

6.4.3

Information screens:

- press or to retrieve the warning history
- press or to scroll through the software menu

► *The last warning code generated is shown first.*

6.4.4 Import machine settings

In this menu the settings of another machine (or from the Bravilor factory) can be imported. With settings the following is meant:

- recipes
- machine configuration
- security levels

► *Only if the identities of both machines are the same the settings can be transferred.*

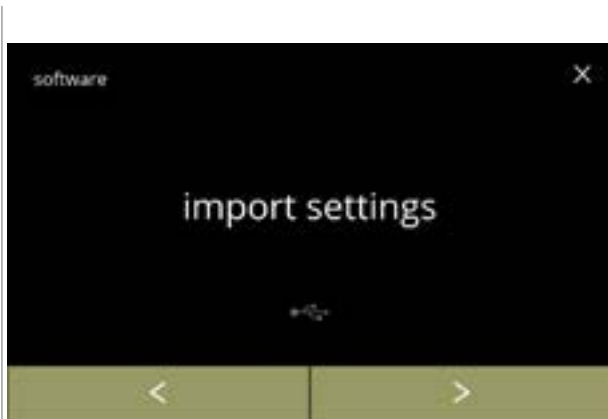

6.4.4

Import machine settings:

- place a USB stick
 - *If there is no USB stick in the machine this option is greyed out.*
- press "import settings" to confirm
- press **◀** or **▶** to scroll through the software menu

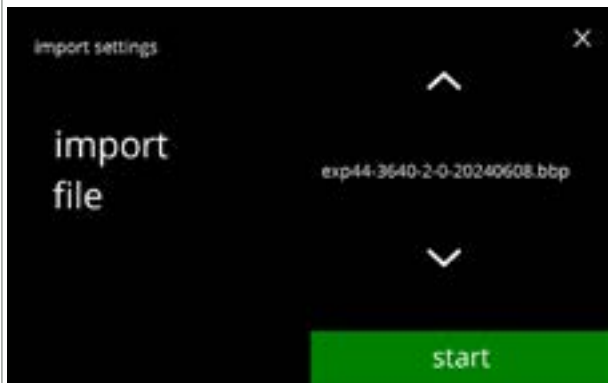

6.4.4a

Import the settings on the machine:

- press **▲** or **▼** to select a setting file
- press **start** to begin the import
 - *It is only possible to import a file with the same identification:*

EXP44	: identical model
3640	: identical boiler power (Watt)
2	: number of outlets
0	: type (0 standard / 1 = XL)
20240807	: date is variable (yyyymmdd)
bbp	: identical file extension

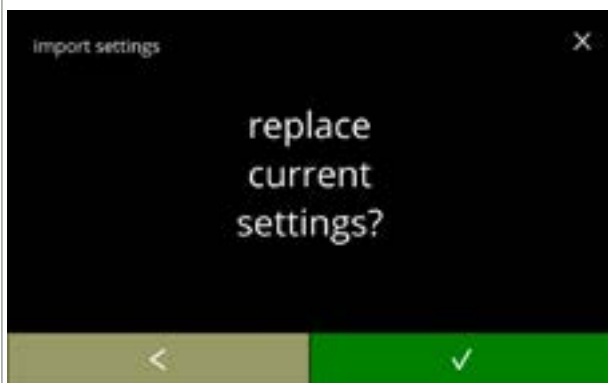

6.4.4b

Confirmation screen:

- press **✓** to confirm
- press **◀** to go to the previous screen

Progress screen

- wait until the process is finished

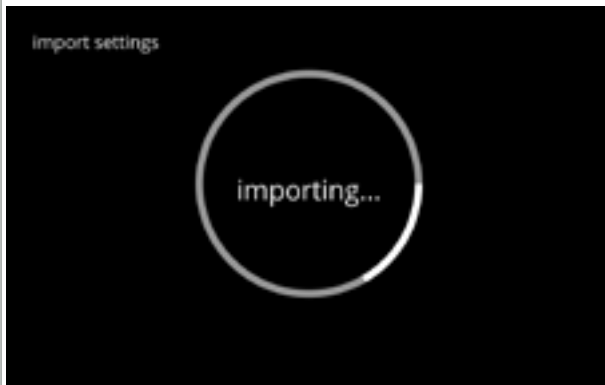

6.4.4c

Information screen:

- screen [6.4.4](#) is displayed after a few seconds

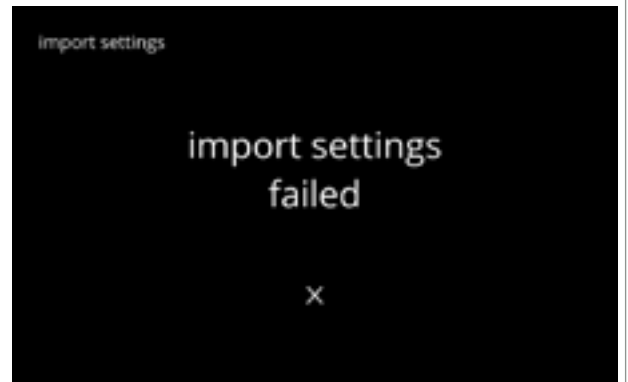
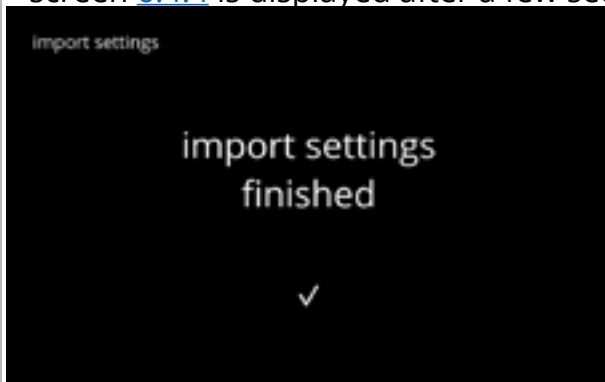

6.4.4d

6.4.5 Export machine settings

In this menu the machine settings are exported to a file.
With settings the following is meant:

- recipes
 - machine configuration
 - security levels
 - identity (used to check if the new machine has the same identity)
- ▶ *Keep in mind that the security levels of the machine are also copied.*

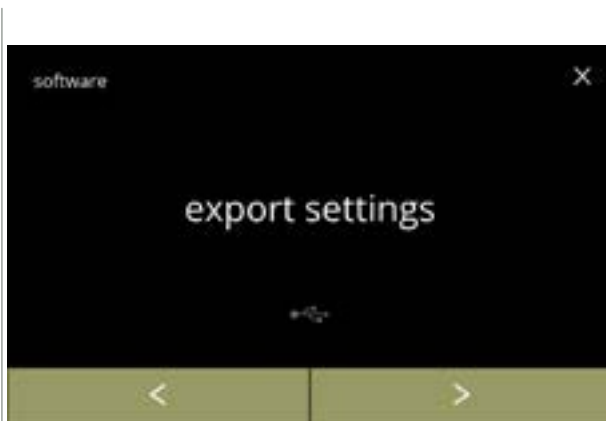

6.4.5

Export machine settings:

- place a USB stick
 - ▶ *If there is no USB stick in the machine this option is greyed out.*
- press "export settings" to confirm
- press **◀** or **▶** to scroll through the software menu

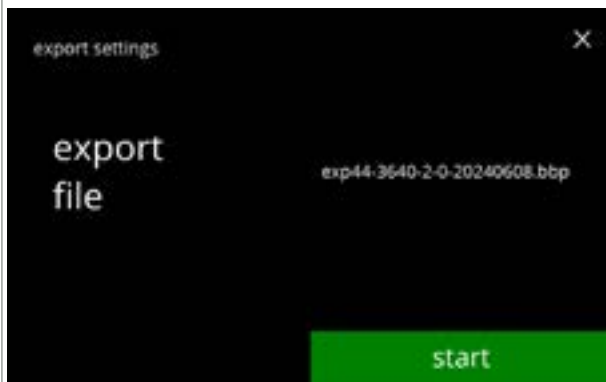

6.4.5a

Export the settings of the current machine:

- press **start** to begin the export
 - ▶ *The name of the export file is structured as follows:*
- | | |
|----------|---------------------------------|
| EXP44 | : identical model |
| 3640 | : identical boiler power (Watt) |
| 2 | : number of outlets |
| 0 | : type (0 standard / 1 = XL) |
| 20240807 | : date is variable (yyyymmdd) |
| bbp | : identical file extension |



6.4.5b

Progress screen

- wait for the process to finish
- press on **cancel** to interrupt

Information screens:

- screen [6.4.5](#) is displayed after a few seconds

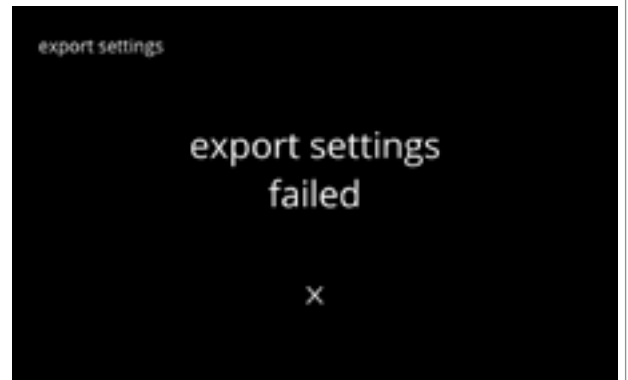
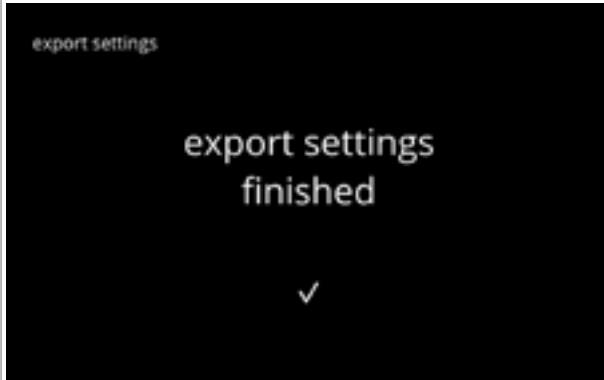

6.4.5c

6.4.6 Update software

In this menu the software can be updated.

The software (package) can be selected from the USB stick and after selection the package information will be shown.

► *The software can be upgraded and downgraded as required.*

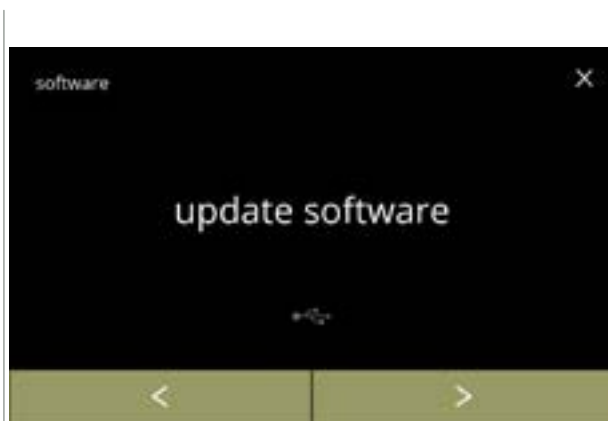

6.4.6

Update the machine software:

- place a USB stick

► *If there is no USB stick in the machine this option is greyed out.*

- press "update software" to confirm
- press **◀** or **▶** to scroll through the software menu

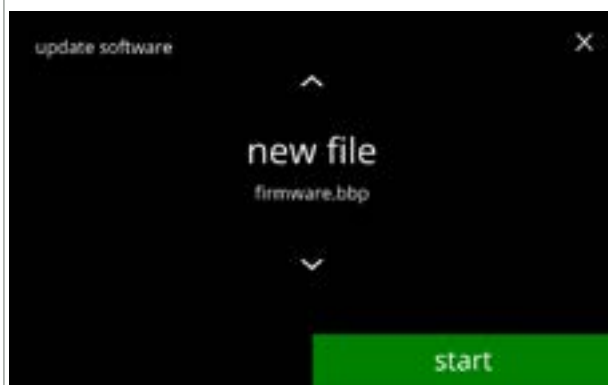

6.4.6a

Select the file to update the software:

- press **▲** or **▼** to select a file

- press **start** to begin the update

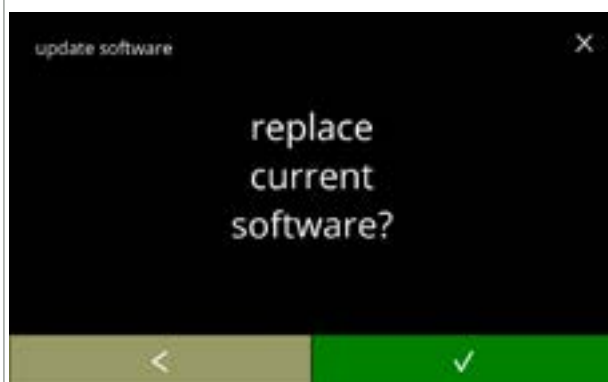

6.4.6b

Confirmation screen:

► *Be aware that your current firmware will be overwritten.*

- press **✓** to confirm

- press **◀** to go to the previous screen



6.4.6c

Progress screen

- wait for the process to finish
- press on **cancel** to interrupt

► *If the file cannot be imported (earlier version or wrong format) the screen is aborted and screen [6.4.6f](#) appears.*

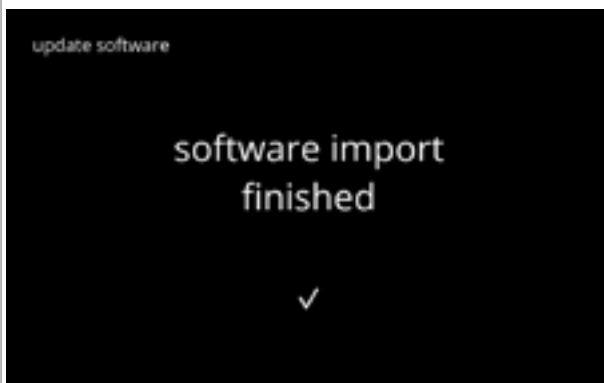

6.4.6d

Information screen:

- the next screen is displayed after a few seconds



6.4.6e

Information screen:

- the machine starts automatically (this takes a while)
- the next screen is displayed automatically

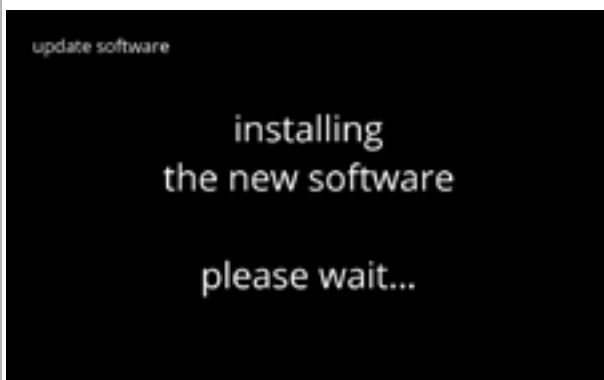

6.4.6f

Information screen:

- the beverage selection screen is displayed when the software is installed

6.4.7 Export machine log

In this menu the machine log is exported to a file.

The report consists of dispense counters (free and paid), warning and error messages.



6.4.7

Export machine log:

- place a USB stick

► *If there is no USB stick in the machine this option is greyed out.*

- press "export machine log" to confirm
- press **<** or **>** to scroll through the software menu

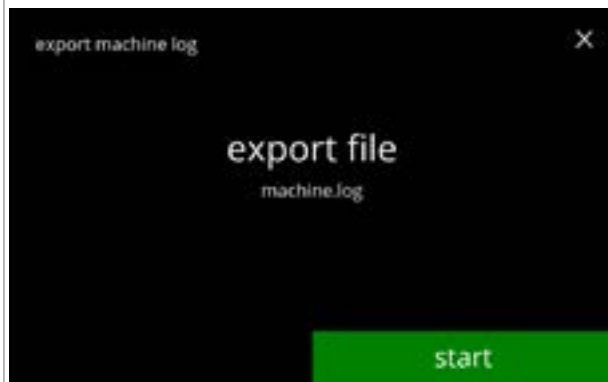

Export the log file of the machine:

- press **start** to begin the export

6.4.7a



Progress screen

- wait for the process to finish
- press on **cancel** to interrupt

6.4.7b

Information screens:

- screen [6.4.7](#) is displayed after a few seconds



6.4.7c

6.4.8 Software update history

In this menu software history is shown.



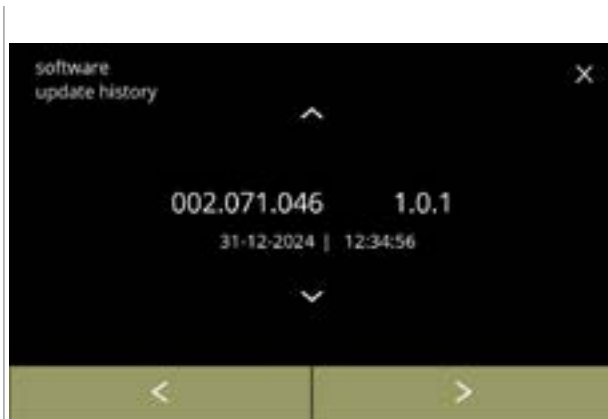

The following software history are shown with item number, version, date and time:

- product software (HMI)
- I/O board software
- touch software
- Wi-Fi/Bluetooth
- bus devices (if they are connected)

The update log can contain up to 50 items, the last update is shown first.



Information screens:

- press  or  to retrieve the update history
- press  or  to scroll through the software menu

6.4.8

6.5 Online info

Online information can be approached via the QR code shown on the screen.
Select one of the available options

- press **◀** or **▶** to select the next option of the “machine menu”
- press the “text area” to select the next level for that menu
- press **✕** to go back to [chapter 6. Programming menu on p.17](#)

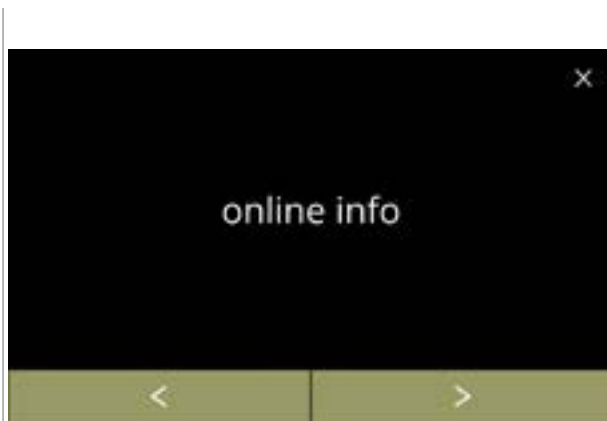

6.5.1

Online information:

- press “online info” to confirm
- press **◀** or **▶** to scroll through the machine menu



6.5.1a

Online manuals:

- press **◀** or **▶** to scroll through the available QR codes
- scan the QR code to get the latest online manual(s)

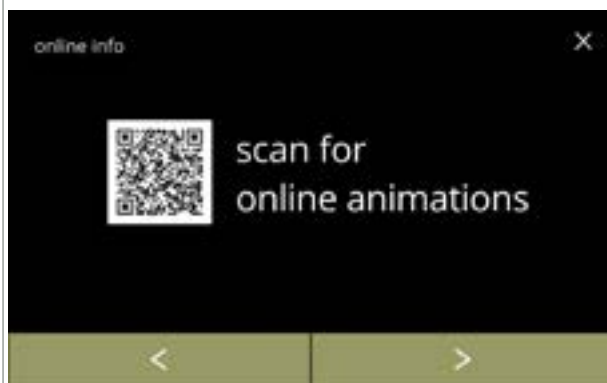

6.5.1b

Online animations:

- press **◀** or **▶** to scroll through the available QR codes
- scan the QR code to get the latest online animation(s)

7. Warnings and errors

7.1 Warnings

Warnings are used to inform you of a state which can prevent the Bolero from working correctly. In general warnings are shown after selecting a beverage.

- ▶ *The messages/warnings are displayed for 30 seconds then return to the home screen.*
 - » a message (Mxxx) is a positive confirmation of a user action.
 - » a warning (Wxxx) indicates a problem or potentially harmful condition.

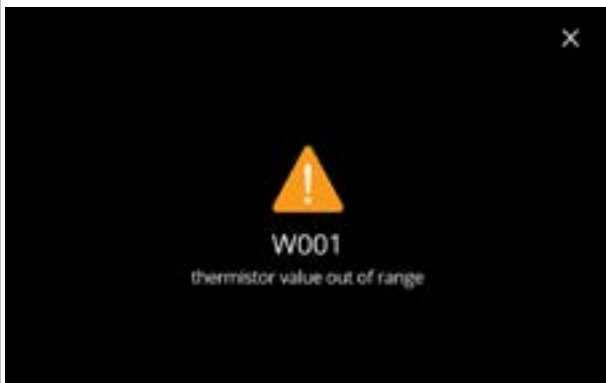

Example display for a warning.
These notifications are stored in a log file ([§6.4.3 on p.121](#)).

7.1a

code	description	action
W001	temperature sensor out of range	<ul style="list-style-type: none"> • no action required, disappears after a few seconds, becomes after 3 incidents E002
W002	temperature too high	<ul style="list-style-type: none"> • no action required, disappears after a few seconds
W003	temperature not rising while relay engaged	<ul style="list-style-type: none"> • no action required, disappears after a few seconds, becomes E004 after 3 incidents within certain time
W004	canister motor not detected	<ul style="list-style-type: none"> • reset the message on the screen
		<ul style="list-style-type: none"> » if the warning persists, contact your dealer
W005	<i>not used</i>	
W006	mixing cups must be rinsed	<ul style="list-style-type: none"> • reset the message on the screen
		<ul style="list-style-type: none"> » rinse the mixing system, see §6.1.1 on p.19
W007	machine must be descaled soon	<ul style="list-style-type: none"> • reset the message on the screen
		<ul style="list-style-type: none"> » schedule the descaling procedure soon
W008	machine must be descaled now	<ul style="list-style-type: none"> • reset the message on the screen (the warning will pop-up after every dispensed beverage)
		<ul style="list-style-type: none"> » descale the machine, see §6.1.2 on p.21

code	description	action
W009	water filter must be changed soon	• reset the message on the screen
		» schedule water filter replacement soon
W010	water filter must be changed now	• reset the message on the screen (the warning will pop-up after every dispensed beverage)
		» replace the water filter and confirm in §6.1.3 on p.28
W011 - W019	<i>not used</i>	
W020	contact your dealer for preventive maintenance	• reset the message on the screen, the message will recur several times after which it becomes E026

7.2 Error messages

Error messages appear when an error is detected by the machines operating system. When the error is active and is cancelled by the user, the machine goes out of safe mode and tries to recover. If the error is not cleared by retrying, the error reappears.

► *If the error message returned after the appropriate action, please contact your dealer.*

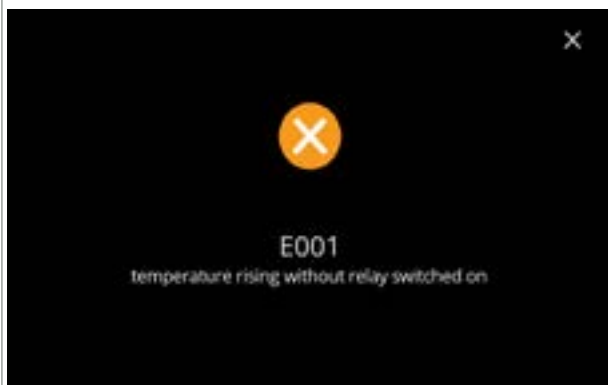

Example display for error messages. These errors are stored in a log file, see [§6.4.2 on p.120](#).

7.2a

code	description	action
E001	temperature rise while relay disengaged	• reset the message on the screen
		» if the error persists, contact your dealer
E002	temperature sensor out of range	• reset the message on the screen
		» if the error persists, contact your dealer
E003	magnetic valve unexpectedly opened	• reset the message on the screen
		» if the error persists, contact your dealer
E004	temperature not rising while relay engaged	• reset the message on the screen
		» if the error persists, contact your dealer
E005	water selector malfunction	• reset the message on the screen
		» if the error persists, contact your dealer

code	description	action
E006	water supply failure	<ul style="list-style-type: none"> • reset the message on the screen, if the error repeats verify the following: <ul style="list-style-type: none"> » check that the water tap is open » check that the water supply hose is not kinked » check whether water comes out of the water tap » if the error persists, contact your dealer
E007	<i>not used</i>	
E008	bus system communication error	<ul style="list-style-type: none"> • reset the message on the screen <ul style="list-style-type: none"> » if the error persists, contact your dealer
E009	pump motor malfunction	<ul style="list-style-type: none"> • reset the message on the screen <ul style="list-style-type: none"> » if the error persists, contact your dealer
E010	mixer motor not detected	<ul style="list-style-type: none"> • reset the message on the screen, if the error repeats verify the following: <ul style="list-style-type: none"> » check that the mixing bowl is clean and not blocked » if the error persists, contact your dealer
E011	canister motor malfunction	<ul style="list-style-type: none"> • reset the message on the screen, if the error repeats verify the following: <ul style="list-style-type: none"> » remove the canister and try again » remove the ingredient powder from the canister and try again » if the error persists, contact your dealer <p>► <i>E011 cannot be detected by the hardware when the canister motor is running at very low speed, i.e. when very small amounts of ingredients are dispensed, which is usually the case for recipes with a very low ingredient/water ratio.</i></p>
E012 - E025	<i>not used</i>	
E026	contact your dealer for necessary maintenance	<ul style="list-style-type: none"> • reset the message on the screen, contact your dealer for required maintenance (the error message will occur more frequently than the previous warning message W020)

7.3 Other problems

In addition to the messages and errors present in the machine, a number of other problems may occur; these problems are described below.

Problem description	Possible cause	Check the following
drink to weak	almost out of powder in ingredient canister	• Ingredient container
	strength not correct	• adjust drink settings in the recipe editor » if the error persists, contact your dealer
drink to strong	strength not correct	• adjust drink settings in the recipe editor » if the error persists, contact your dealer
no water dosed	hose blocked	• contact your dealer
mixing unit clogs up	mixing unit not cleaned	• clean the mixing unit
	to much powder	• check the advise dosing of the packaging of the powder, use a scale to weight the amount of powder used
	powder used which is not applicable for vending machines	• use powder that is applicable for vending machines
	pump calibration not correct	• calibrate the pump (availability depends on PIN setting)
		• contact your dealer
	mixer defect or missing	• check the mixer
	mixing unit damaged	• check the mixing unit
fan rotor does not turn	• clean the fan rotor and housing or remove any blockage » if the error persists, contact your dealer	
mixing unit overflows water	pump calibration not correct	• calibrate the pump (availability depends on PIN setting) • contact your dealer
	mixing bowl clogged up	• mixing bowl, see previous described problem » if the error persists, contact your dealer
mixing unit leaks	mixing bowl seal leaks	• clean the complete mixing unit » if the error persists, contact your dealer

Problem description	Possible cause	Check the following
no foam on the drink	mixer speed not correct	<ul style="list-style-type: none"> • adjust the mixer speed (availability depends on PIN setting) » if the error persists, contact your dealer
	type of instant ingredient	<ul style="list-style-type: none"> • try a different instant ingredient
to much foam on the drink	mixer speed not correct	<ul style="list-style-type: none"> • adjust the mixer speed (availability depends on PIN setting) » if the error persists, contact your dealer
	scale in the water system	<ul style="list-style-type: none"> • descale the machine » if the error persists, contact your dealer
fan rotor does not run	fan not cleaned	<ul style="list-style-type: none"> • clean the fan rotor and housing or remove any blockage » if the error persists, contact your dealer
	scale in water selector	<ul style="list-style-type: none"> • descale the machine » if the error persists, contact your dealer
machine doesn't turn on	switch not turned on	<ul style="list-style-type: none"> • turn on the switch on the backside
	no power	<ul style="list-style-type: none"> • check the power supply » if the error persists, contact your dealer
message safety circuit interrupted in the display	door and lid not closed	<ul style="list-style-type: none"> • first close the lid and then the door
	service key not placed	<ul style="list-style-type: none"> • place the service key » if the error persists, contact your dealer
touch screen display sometimes not responsive	touch screen filthy	<ul style="list-style-type: none"> • turn off the machine and clean the touch screen with a damp cloth ► <i>Do not use aggressive detergents.</i> » if the error persists, contact your dealer

8. Appendix

8.1 Filter information and water hardness

	very soft	soft	average	moderate	hard
°dH	0 - 4	4 - 8	8 - 12	12 - 18	18 - 30
°fH/°TH	0 - 7	7 - 15	15 - 22	22 - 32	32 - 54
°e / Clark	0 - 5	5 - 10	10 - 15	15 - 23	23 - 38
mmol/l	0 - 0.72	0,72 - 1.43	1.43 - 2.15	2.15 - 3.22	3.22 - 5.37
descale	2000 l.	1500 l.	1000 l.	500 l.	250 l.

► *The capacity of a water filter depends on the type and local hardness of the water.*

► *See [§6.1.6 on p.34](#) to set the water hardness.*

8.2 Door switch functionality



When the door opens the safety switch is activated and a message is shown.

The following hardware will become inactive:

- all mixers
- all canisters
- boiler
- appliances that are connected to the 24V safety of the bus system

► *When the door switch is activated during dosing of a beverage, the dosing is cancelled and the mixer cup is cleaned by a post flush.*

8.3 Basic machine configurations

8.3.3 Bolero Turbo (standard)

Turbo 22

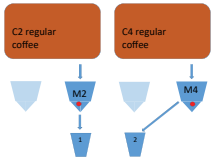

Turbo 33

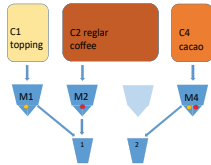

Turbo 33 Self

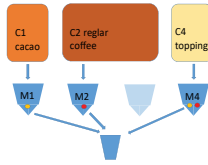

Turbo 43

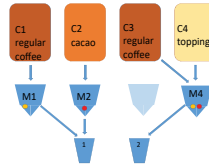

Turbo 44

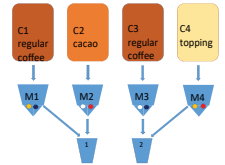

8.3.1 Bolero Turbo (specials)

Turbo 32 (CR*)

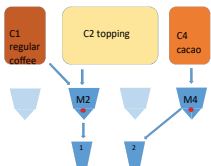

Turbo 42 (CR*)

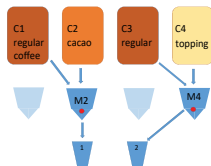

Turbo 43 Self (CR*)

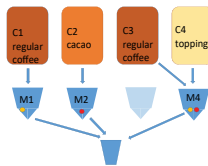

*CR = Commercial request

8.3.2 Bolero Turbo XL (standard)

Turbo XL 33

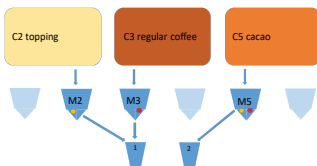

Turbo XL 33 Self

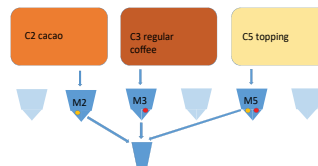

Turbo XL 43

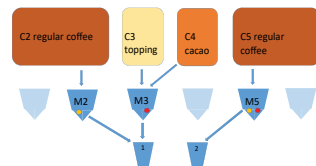

Turbo XL 44

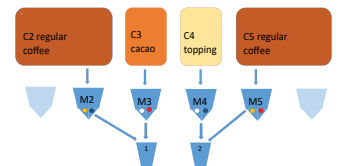

Turbo XL 53

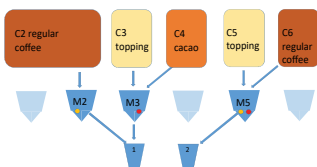

Turbo XL 64

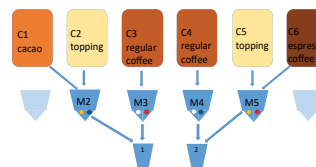

► There are currently no CR models of the Bolero Turbo XL available.

8.3.4 Pre-selected ingredients and beverages

Bolero Turbo 22

	Canister	Canister motor position	Ingredients
	1	2	Regular coffee
	2	4	Regular coffee

Button	Recipes	Cup/mug/jug (ml)	Left	Right	Simultaneous
1	black coffee	120/150/300	✓	✓	✓
2	espresso	60/ 80/120	✓	✓	✓
3	café crème	120/150/300	✓	✓	✓
9	hot water	120/150/300	In the middle		✗

Bolero Turbo 33

	Canister	Canister motor position	Ingredients
	1	1	Topping
	2	2	Regular coffee
	4	4	Cacao

Button	Recipes	Cup/mug/jug (ml)	Left	Right	Simultaneous
1	black coffee	120/150/300	✓	✗	✓
2	espresso	60/ 80/120	✓	✗	✓
3	café crème	120/150/300	✓	✗	✓
4	coffee + milk	120/150/300	✓	✗	✗
5	cappuccino	120/150/300	✓	✗	✗
6	latte macchiato	120/150/300	✓	✗	✗
7	hot milk	120/150/300	✓	✗	✓
8	hot chocolate	120/150/300	✗	✓	✓
9	hot water	120/150/300	in the middle		✗
19	jug black coffee	1000/1500/2000	✓	✗	✓
20	jug hot milk	1000/1500/2000	✓	✗	✓
21	jug hot chocolate	1000/1500/2000	✗	✓	✓
27	jug hot water	1000/1500/2000	in the middle		✗

Bolero Turbo 33 S

	Canister	Canister motor position	Ingredients
	1	1	Cacao
	2	2	Regular coffee
	4	4	Topping

Button	Recipes	Cup/mug/jug (ml)	Single outlet	Simultaneous
1	black coffee	120/150/300	✓	✗
2	espresso	60/ 80/120	✓	✗
3	café crème	120/150/300	✓	✗
4	coffee + milk	120/150/300	✓	✗
5	cappuccino	120/150/300	✓	✗
6	latte macchiato	120/150/300	✓	✗
7	hot milk	120/150/300	✓	✗
8	hot chocolate	120/150/300	✓	✗
9	hot water	120/150/300	✓	✗
19	jug black coffee	1000/1500/2000	✓	✗
20	jug hot milk	1000/1500/2000	✓	✗
21	jug hot chocolate	1000/1500/2000	✓	✗
27	jug hot water	1000/1500/2000	✓	✗

Bolero Turbo 43

	Canister	Canister motor position	Ingredients
	1	1	Regular coffee
	2	2	Cacao
	4	4	Topping

Button	Recipes	Cup/mug/jug (ml)	Left	Right	Simultaneous
1	black coffee	120/150/300	✓	✓	✓
2	espresso	60/ 80/120	✓	✓	✓
3	café crème	120/150/300	✓	✓	✓
4	coffee + milk	120/150/300	✗	✓	✗
5	cappuccino	120/150/300	✗	✓	✗
6	latte macchiato	120/150/300	✗	✓	✗
7	hot milk	120/150/300	✗	✓	✓
8	hot chocolate	120/150/300	✗	✗	✓
9	hot water	120/150/300	in the middle		✗
19	jug black coffee	1000/1500/2000	✓	✓	✓
20	jug hot milk	1000/1500/2000	✗	✓	✓
21	jug hot chocolate	1000/1500/2000	✓	✗	✓
27	jug hot water	1000/1500/2000	in the middle		✗

Bolero Turbo 44

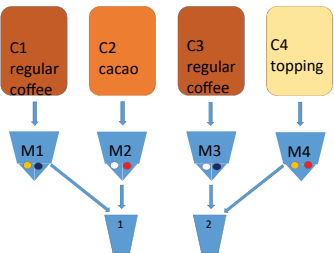
	Canister	Canister motor position	Ingredients
	1	1	Regular coffee
	2	2	Cacao
	3	3	Regular coffee
	4	4	Topping

Button	Recipes	Cup/mug/jug (ml)	Left	Right	Simultaneous
1	black coffee	120/150/300	✓	✓	✓
2	espresso	60/ 80/120	✓	✓	✓
3	café crème	120/150/300	✓	✓	✓
4	coffee + milk	120/150/300	✗	✓	✗
5	cappuccino	120/150/300	✗	✓	✗
6	latte macchiato	120/150/300	✗	✓	✗
7	hot milk	120/150/300	✗	✓	✗
8	hot chocolate	120/150/300	✓	✗	✗
9	hot water	120/150/300	in the middle		✗
19	jug black coffee	1000/1500/2000	✓	✓	✓
20	jug hot milk	1000/1500/2000	✗	✓	✓
21	jug hot chocolate	1000/1500/2000	✓	✗	✓
27	jug hot water	1000/1500/2000	in the middle		✗

Bolero Turbo XL 33

	Canister	Canister motor position	Ingredients
	1	2	Topping
	2	3	Regular coffee
	3	5	Cacao

Button	Recipes	Cup/mug/jug (ml)	Left	Right	Simultaneous
1	black coffee	120/150/300	✓	✗	✓
2	espresso	60/ 80/120	✓	✗	✓
3	café crème	120/150/300	✓	✗	✓
4	coffee + milk	120/150/300	✓	✗	✗
5	cappuccino	120/150/300	✓	✗	✗
6	latte macchiato	120/150/300	✓	✗	✗
7	hot milk	120/150/300	✓	✗	✓
8	hot chocolate	120/150/300	✗	✓	✓
9	hot water	120/150/300	in the middle		✗
19	jug black coffee	1000/1500/2000	✓	✓	✓
20	jug hot milk	1000/1500/2000	✓	✗	✓
21	jug hot chocolate	1000/1500/2000	✗	✓	✓
27	jug hot water	1000/1500/2000	in the middle		✗

Bolero Turbo XL 33 S

	Canister	Canister motor position	Ingredients
	1	2	Cacao
	2	3	Regular coffee
	3	5	Topping

Button	Recipes	Cup/mug/jug (ml)	Single outlet	Simultaneous
1	black coffee	120/150/300	✓	✗
2	espresso	60/ 80/120	✓	✗
3	café crème	120/150/300	✓	✗
4	coffee + milk	120/150/300	✓	✗
5	cappuccino	120/150/300	✓	✗
6	latte macchiato	120/150/300	✓	✗
7	hot milk	120/150/300	✓	✗
8	hot chocolate	120/150/300	✓	✗
9	hot water	120/150/300	✓	✗
19	jug black coffee	1000/1500/2000	✓	✗
20	jug hot milk	1000/1500/2000	✓	✗
21	jug hot chocolate	1000/1500/2000	✓	✗
27	jug hot water	1000/1500/2000	✓	✗

Bolero Turbo XL 43

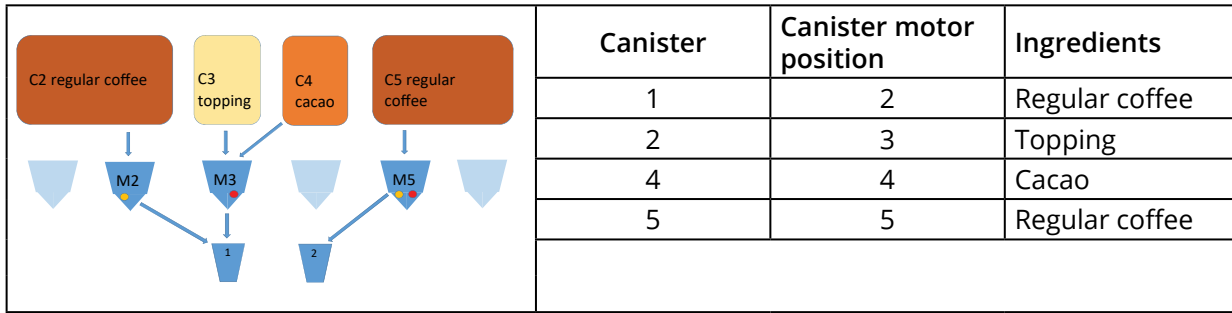

Button	Recipes	Cup/mug/jug (ml)	Left	Right	Simultaneous
1	black coffee	120/150/300	✓	✓	✓
2	espresso	60/ 80/120	✓	✓	✓
3	café crème	120/150/300	✓	✓	✓
4	coffee + milk	120/150/300	✓	✗	✗
5	cappuccino	120/150/300	✓	✗	✗
6	latte macchiato	120/150/300	✓	✗	✗
7	hot milk	120/150/300	✓	✗	✓
8	hot chocolate	120/150/300	✓	✗	✓
9	hot water	120/150/300	in the middle		✗
19	jug black coffee	1000/1500/2000	✓	✓	✓
20	jug hot milk	1000/1500/2000	✓	✗	✓
21	jug hot chocolate	1000/1500/2000	✓	✗	✓
27	jug hot water	1000/1500/2000	in the middle		✗

Bolero Turbo XL 44

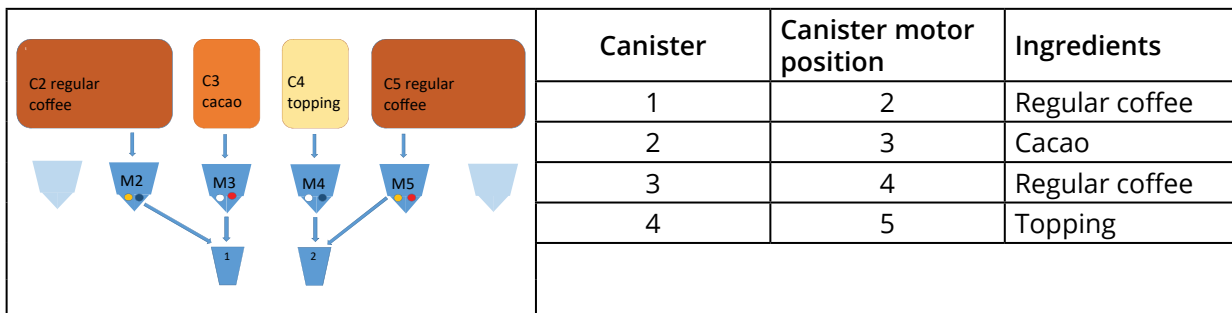

Button	Recipes	Cup/mug/jug (ml)	Left	Right	Simultaneous
1	black coffee	120/150/300	✓	✓	✓
2	espresso	60/ 80/120	✓	✓	✓
3	café crème	120/150/300	✓	✓	✓
4	coffee + milk	120/150/300	✗	✓	✗
5	cappuccino	120/150/300	✗	✓	✗
6	latte macchiato	120/150/300	✗	✓	✗
7	hot milk	120/150/300	✗	✓	✗
8	hot chocolate	120/150/300	✓	✗	✓
9	hot water	120/150/300	in the middle		✗
19	jug black coffee	1000/1500/2000	✓	✓	✓
20	jug hot milk	1000/1500/2000	✗	✓	✓
21	jug hot chocolate	1000/1500/2000	✓	✗	✓
27	jug hot water	1000/1500/2000	in the middle		✗

Bolero Turbo XL 53

	Canister	Canister motor position	Ingredients
	1	2	Regular coffee
	2	3	Topping
	3	4	Cacao
	4	5	Topping
	5	6	Regular coffee

Button	Recipes	Cup/mug/jug (ml)	Left	Right	Simultaneous
1	black coffee	120/150/300	✓	✓	✓
2	espresso	60/ 80/120	✓	✓	✓
3	café crème	120/150/300	✓	✓	✓
4	coffee + milk	120/150/300	✓	✓	✗
5	cappuccino	120/150/300	✓	✓	✗
6	latte macchiato	120/150/300	✓	✓	✗
7	hot milk	120/150/300	✓	✓	✓
8	hot chocolate	120/150/300	✓	✗	✓
9	hot water	120/150/300	in the middle		✗
19	jug black coffee	1000/1500/2000	✓	✓	✓
20	jug hot milk	1000/1500/2000	✓	✓	✓
21	jug hot chocolate	1000/1500/2000	✓	✗	✓
27	jug hot water	1000/1500/2000	in the middle		✗

Bolero Turbo XL 64

	Canister	Canister motor position	Ingredients
	1	1	Cacao
	2	2	Topping
	3	3	Regular coffee
	4	5	Regular coffee
	5	5	Topping
6	6	Espresso coffee	

Button	Recipes	Cup/mug/jug (ml)	Left	Right	Simultaneous
1	black coffee	120/150/300	✓	✓	✓
2	espresso	60/ 80/120	✓	✓	✓
3	café crème	120/150/300	✓	✓	✓
4	coffee + milk	120/150/300	✓	✓	✗
5	cappuccino	120/150/300	✓	✓	✗
6	latte macchiato	120/150/300	✓	✓	✗
7	hot milk	120/150/300	✓	✓	✓
8	hot chocolate	120/150/300	✓	✗	✓
9	hot water	120/150/300	in the middle		✗
19	jug black coffee	1000/1500/2000	✓	✓	✓
20	jug hot milk	1000/1500/2000	✓	✓	✓
21	jug hot chocolate	1000/1500/2000	✓	✗	✓
27	jug hot water	1000/1500/2000	in the middle		✗

Section	Menu name	PIN 1	PIN 2	without PIN
6.2	Beverage menu	✓	✓	✗
6.2.1	Add beverage to screen	✓	✓	✗
6.2.2	Change beverage name	✓	✓	✗
6.2.3	Change beverage icon	✓	✓	✗
6.2.4	Change beverage price	✓	✓	✗
6.2.5	Recipes	✓	✓	✗
	recipe editor	✓	✓	✗
	recipe builder	✓	✓	✗
	delete recipe	✓	✓	✗
6.2.6	Select ingredients canisters	✓	✓	✗
6.2.7	Change ingredient name	✓	✓	✗
6.2.8	Customize default strength	✓	✓	✗
6.2.9	Set default volume	✓	✓	✗
6.2.10	Simultaneously dispensable beverages	✓	✓	✗
6.3	Machine menu	✓	✓	✗
6.3.1	Date	✓	✓	✗
6.3.2	Time	✓	✓	✗
6.3.3	Language	✓	✓	✗
6.3.4	Screensaver management	✓	✓	✗
6.3.5	Background	✓	✓	✗
6.3.6	Display brightness	✓	✓	✗
6.3.7	Sound level feedback	✓	✓	✗
6.3.8	Boiler temperature	✓	✓	✗
6.3.9	Energy-saving mode (ECO)	✓	✓	✗
6.3.10	Security settings	✓	✓	✗
6.3.11	Connected devices	✓	✓	✗
6.3.12	Reset to factory settings	✓	✗	✗
6.3.13	Set blocking times	✓	✓	✗
6.3.14	Set automatic ON/OFF times	✓	✓	✗
6.4	Software menu	✓	✓	✓
6.4.1	Machine and software information	✓	✓	✓
6.4.2	Error log	✓	✓	✗
6.4.3	Warning log	✓	✓	✗
6.4.4	Import machine settings	✓	✗	✗
6.4.5	Export machine settings	✓	✗	✗
6.4.6	Update software	✓	✗	✗
6.4.7	Export machine log	✓	✗	✗
6.4.8	Software update history	✓	✗	✗
6.5	Online info	✓	✓	✓

► Menu items secured by PIN codes will be greyed out, see [§6.3.10 on p.105](#) to set the PIN codes.

8.5 Special functions

By using a “secret key combination” special features can be activated.

8.5.1 Cancel beverage on/off

See [§6.3.11 on p.110](#).

- ▶ Reason of this feature is that the customer can choose if the beverage can be cancelled or not when a payment system is connected.

8.5.2 Quick rinse

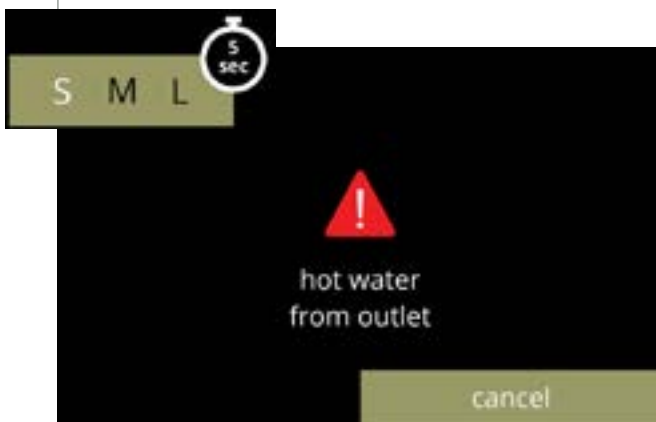

By pressing the S M L on the beverage selection screen for 5 seconds the quick rinse is immediately activated with 90 ml (hot water) per mixing system.

- ▶ To set this function, see [§6.1.4 on p.31](#).

**Brewing
your coffee**
S I N C E 1 9 4 8